



PROFESSIONAL COMPACT DISC RECORDER **CDR-830**



BurnIT
CDR830 COMPACT DISC RECORDER

Operating Instructions

La versión en español del manual de operaciones la encontrará en la web de HHB www.hhb.co.uk
La version Française de ce manuel d'utilisation est disponible sur le site web de HHB à www.hhb.co.uk
Eine deutsche Version dieser Bedienungsanleitung ist im Internet unter der Adresse www.hhb.co.uk erhältlich.



IMPORTANT



The lightning flash with arrowhead symbol, within an equilateral triangle, is intended to alert the user to the presence of uninsulated "dangerous voltage" within the product's enclosure that may be of sufficient magnitude to constitute a risk of electric shock to persons.

CAUTION

RISK OF ELECTRIC SHOCK
DO NOT OPEN



The exclamation point within an equilateral triangle is intended to alert the user to the presence of important operating and maintenance (servicing) instructions in the literature accompanying the appliance.

IMPORTANT SAFETY INSTRUCTIONS

READ INSTRUCTIONS — All the safety and operating instructions should be read before the product is operated.

RETAIN INSTRUCTIONS — The safety and operating instructions should be retained for future reference.

HEED WARNINGS — All warnings on the product and in the operating instructions should be adhered to.

FOLLOW INSTRUCTIONS — All operating and use instructions should be followed.

CLEANING — Unplug this product from the wall outlet before cleaning. The product should be cleaned only with a polishing cloth or a soft dry cloth. Never clean with furniture wax, benzene, insecticides or other volatile liquids since they may corrode the cabinet.

ATTACHMENTS — Do not use attachments not recommended by the product manufacturer as they may cause hazards.

WATER AND MOISTURE — Do not use this product near water — for example, near a bathtub, wash bowl, kitchen sink, or laundry tub; in a wet basement; or near a swimming pool; and the like.

ACCESSORIES — Do not place this product on an unstable cart, stand, tripod, bracket, or table. The product may fall, causing serious injury to a child or adult, and serious damage to the product. Use only with a cart, stand, tripod, bracket, or table recommended by the manufacturer, or sold with the product. Any mounting of the product should follow the manufacturer's instructions, and should use a mounting accessory recommended by the manufacturer.

CART — A product and cart combination should be moved with care. Quick stops, excessive force, and uneven surfaces may cause the product and cart combination to overturn.



VENTILATION — Slots and openings in the cabinet are provided for ventilation and to ensure reliable operation of the product and to protect it from overheating, and these openings must not be blocked or covered. The openings should never be blocked by placing the product on a bed, sofa, rug, or other similar surface. This product should not be placed in a built-in installation such as a bookcase or rack unless proper ventilation is provided or the manufacturer's instructions have been adhered to.

POWER SOURCES — This product should be operated only from the type of power source indicated on the marking label. If you are not sure of the type of power supply to your home, consult your product dealer or local power company.

LOCATION — The appliance should be installed in a stable location.

NONUSE PERIODS — The power cord of the appliance should be unplugged from the outlet when left unused for a long period of time.

GROUNDING OR POLARIZATION

● If this product is equipped with a polarized alternating current line plug (a plug having one blade wider than the other), it will fit into the outlet only one way. This is a safety feature. If you are unable to insert the plug fully into the outlet, try reversing the plug. If the plug should still fail to fit, contact your electrician to replace your obsolete outlet. Do not defeat the safety purpose of the polarized plug.

● If this product is equipped with a three-wire grounding type plug, a plug having a third (grounding) pin, it will only fit into a grounding type power outlet. This is a safety feature. If you are unable to insert the plug into the outlet, contact your electrician to replace your obsolete outlet. Do not defeat the safety purpose of the grounding type plug.

POWER-CORD PROTECTION — Power-supply cords should be routed so that they are not likely to be walked on or pinched by items placed upon or against them, paying particular attention to cords at plugs, convenience receptacles, and the point where they exit from the product.

OUTDOOR ANTENNA GROUNDING — If an outside antenna or cable system is connected to the product, be sure the antenna or cable system is grounded so as to provide some protection against voltage surges and built-up static charges. Article 810 of the National Electrical Code, ANSI/NFPA 70, provides information with regard to proper grounding of the mast and supporting structure, grounding of the lead-in wire to an antenna discharge unit, size of grounding conductors, location of antenna-discharge unit, connection to grounding electrodes, and requirements for the grounding electrode. See Figure A.

LIGHTNING — For added protection for this product during a lightning storm, or when it is left unattended and unused for long periods of time, unplug it from the wall outlet and disconnect the antenna or cable system. This will prevent damage to the product due to lightning and power-line surges.

POWER LINES — An outside antenna system should not be located in the vicinity of overhead power lines or other electric light or power circuits, or where it can fall into such power lines or circuits. When installing an outside antenna system, extreme care should be taken to keep from touching such power lines or circuits as contact with them might be fatal.

OVERLOADING — Do not overload wall outlets, extension cords, or integral convenience receptacles as this can result in a risk of fire or electric shock.

OBJECT AND LIQUID ENTRY — Never push objects of any kind into this product through openings as they may touch dangerous voltage points or short-out parts that could result in a fire or electric shock. Never spill liquid of any kind on the product.

SERVICING — Do not attempt to service this product yourself as opening or removing covers may expose you to dangerous voltage or other hazards. Refer all servicing to qualified service personnel.

DAMAGE REQUIRING SERVICE — Unplug this product from the wall outlet and refer servicing to qualified service personnel under the following conditions:

- When the power-supply cord or plug is damaged.
- If liquid has been spilled, or objects have fallen into the product.
- If the product has been exposed to rain or water.
- If the product does not operate normally by following the operating instructions. Adjust only those controls that are covered by the operating instructions as an improper adjustment of other controls may result in damage and will often require extensive work by a qualified technician to restore the product to its normal operation.

- If the product has been dropped or damaged in any way.
- When the product exhibits a distinct change in performance — this indicates a need for service.

REPLACEMENT PARTS — When replacement parts are required, be sure the service technician has used replacement parts specified by the manufacturer or have the same characteristics as the original part. Unauthorized substitutions may result in fire, electric shock, or other hazards.

SAFETY CHECK — Upon completion of any service or repairs to this product, ask the service technician to perform safety checks to determine that the product is in proper operating condition.

WALL OR CEILING MOUNTING — The product should not be mounted to a wall or ceiling.

HEAT — The product should be situated away from heat sources such as radiators, heat registers, stoves, or other products (including amplifiers) that produce heat.

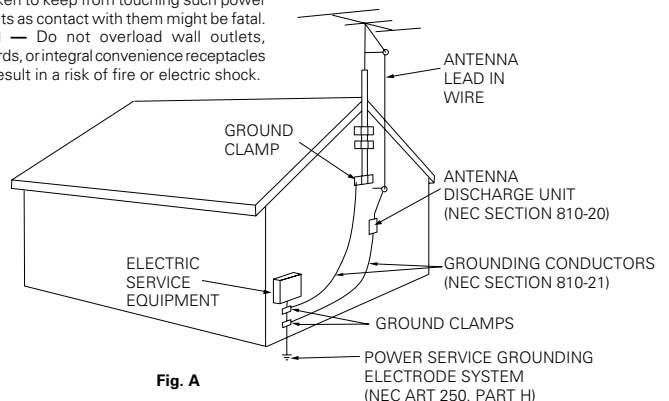

Fig. A

NEC — NATIONAL ELECTRICAL CODE

WARNING: THE APPARATUS IS NOT WATERPROOF, TO PREVENT FIRE OR SHOCK HAZARD, DO NOT EXPOSE THIS APPLIANCE TO RAIN OR MOISTURE AND DO NOT PUT ANY WATER SOURCE OR FLUID CONTAINER NEAR THIS APPARATUS.

WARNING: THIS PRODUCT EQUIPPED WITH A THREE-WIRE GROUNDING (EARTHING) TYPE PLUG, A PLUG HAVING A THIRD (GROUNDING, EARTHING) PIN, WILL ONLY FIT INTO A GROUNDING (EARTHING) TYPE POWER OUTLET. THIS IS A SAFETY FEATURE. IF YOU ARE UNABLE TO INSERT THE PLUG INTO THE OUTLET, CONTACT YOUR ELECTRICIAN TO REPLACE YOUR OUTLET. DO NOT DEFEAT THE SAFETY PURPOSE OF THE GROUNDING (EARTHING) TYPE PLUG.

WARNING: NO NAKED FLAME SOURCES, SUCH AS LIGHTED CANDLE, SHOULD BE PLACED ON OR NEAR THE APPARATUS.

[For Canadian model]

This Class B digital apparatus complies with Canadian ICES-003.

[Pour le modèle Canadien]

Cet appareil numérique de la classe B est conforme à la norme NMB-003 du Canada.

[For U.S. model]

DANGER – LASER RADIATION WHEN OPEN.

AVOID DIRECT EXPOSURE TO BEAM.

This caution can be found on the rear panel of the unit.

WARNING: Slot and openings in the cabinet are provided for ventilation and to ensure reliable operation of the product and to protect it from overheating, to prevent fire hazard, the openings should never be blocked and covered with items, such as newspapers, table-cloths, curtains, etc. Also do not put the apparatus on the thick carpet, bed, sofa, or fabric having a thick pile.

CAUTION:

- Use of controls or adjustments or performance of procedures other than those specified herein hazardous radiation exposure.
- The use of optical instruments with this product will increase eye hazard.

NOTE: This equipment has been tested and found to comply with the limits for a Class B digital device, pursuant to Part 15 of the FCC Rules. These limits are designed to provide reasonable protection against harmful interference in a residential installation. This equipment generates, uses, and can radiate radio frequency energy and, if not installed and used in accordance with the instructions, may cause harmful interference to radio communications. However, there is no guarantee that interference will not occur in a particular installation. If this equipment does cause harmful interference to radio or television reception, which can be determined by turning the equipment off and on, the user is encouraged to try to correct the interference by one or more of the following measures:

- Reorient or relocate the receiving antenna.
- Increase the separation between the equipment and receiver.
- Connect the equipment into an outlet on a circuit different from that to which the receiver is connected.
- Consult the dealer or an experienced radio/TV technician for help.

CAUTION:

This product satisfies FCC regulations when shielded cables and connectors are used to connect the unit to other equipment. To prevent electromagnetic interference with electric appliances such as radios and televisions, use shielded cables and connectors for connections.

Information to User

Alteration or modifications carried out without appropriate authorization may invalidate the user's right to operate the equipment.

Thank you for buying the HHB CDR-830 Professional Compact Disc recorder. The CDR-830 is designed to make the professional CD recording process as straightforward as possible. However we do recommend that you read these operating instructions carefully, and keep them in a safe place for future reference.

In some countries, the shape of the power plug and outlet may differ from that shown in the explanatory drawings. The method of connecting and operating the unit is, however, the same.

IMPORTANT NOTICE: Please register ownership of your CDR-830 with HHB Communications using the supplied card. Registration could assist in the recovery of your CDR-830 in the unfortunate event of theft.

A WORD ABOUT DISCS: Your HHB CDR-830 Professional CD Recorder is designed to operate with a broad range of blank CD-R media. However, for consistently high quality results and superior archiving stability, we recommend that you ask your dealer for HHB CD-R discs.

This product complies with the Low Voltage Directive (73/23/EEC, amended by 93/68/EEC), EMC Directives (89/336/EEC, 92/31/EEC and 93/68/EEC).

CAUTION

This product contains a laser diode of higher class than 1. To ensure continued safety, do not remove any covers or attempt to gain access to the inside of the product.

Refer all servicing to qualified personnel.

The following caution label appears on your unit.

Location: Rear of the unit.



CAUTION: THE POWER SWITCH DOES NOT COMPLETELY SEPARATE THE UNIT FROM THE MAINS IN THE OFF POSITION, THEREFORE INSTALL THE UNIT IN A SUITABLE PLACE FOR EASY DISCONNECTION OF THE MAINS PLUG IN CASE OF AN ACCIDENT. THE MAINS PLUG OF THE UNIT SHOULD BE UNPLUGGED FROM THE WALL SOCKET IF THE UNIT IS LEFT UNUSED FOR A LONG PERIOD OF TIME.

Operating Environment

Operating environment temperature and humidity: +5°C – +35°C (+41F – +95F); less than 85%RH (cooling vents not blocked)

Do not install in the following locations

- Location exposed to direct sunlight or strong artificial light
- Location exposed to high humidity, or poorly ventilated location

Bij dit product zijn batterijen geleverd. Wanneer deze leeg zijn, moet u ze niet weggooien maar inleveren als KCA.

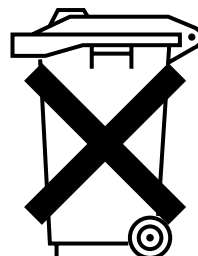

Contents

1 Before You Start

Feature of the CDR-830 BurniT CD recorder	6
Checking what's in the box	6
Using this manual	6
Hints on installation	6
Putting the batteries in the remote control ...	7
Avoiding condensation problems	7
Care and maintenance	7
Cleaning external surfaces	7
Moving the unit	7
Storing optical cable	7
Handling discs	7
Storing discs	8
Discs to avoid	8
CD lens cleaner	8
About CD, CD-R and CD-RW discs	8
Playback-only CDs	8
CD-Recordable discs	8
CD-Rewritable discs	8
CD TEXT discs	8
Recording and finalizing discs	9
Recording copyright material	9

2 Connecting Up

Connecting up for digital playback & recording	10
About optical and coaxial jacks	10
Using the digital inputs	10
Using the digital outputs	10
Connecting up for analog playback & recording	11
POWER-CORD CAUTION	11

3 Controls and Displays

Front panel	12
Remote control	13
Display	14

4 Getting Started

Switching on for the first time	15
Selecting tracks directly	16
Using the menu features	16
Showing CD text information	16
Showing disc information	17
Introduction to CD recording	17
Digital recording restrictions	17
Recording modes	18
Miscellaneous information	18
Digital recording from DAT	18
Digital signal interruptions	18
Power interruptions	18
Recording one track from a source	19
Recording all tracks from a source	20
Automatically recording and finalizing a disc	21

Manual recording	22
Setting the digital recording level	23
Setting the analog recording level	24
Setting the balance	25
Finalizing a disc	26
Resetting the recorder	26

5 More Playback Features

Programming the track order	27
Clearing the playlist	27
Clearing a track from the playlist	27
Checking what's in the playlist	27
Replacing a track in the playlist	27
Playing tracks at random	28
Repeating tracks	28
Fading in and fading out	28
Playing a disc with skip IDs	28
Skipping unwanted tracks	29
Setting skip IDs	29
Clearing skip IDs	29

6 More Recording Features

Using CD text	30
Editing CD text	31
Copying track names to other tracks	32
Automatically numbering tracks	33
Manually numbering tracks	33
Starting tracks in time increments	34
Recording fade ins and fade outs	34
Setting the fade length	34
Recording a fade in	34
Recording a fade out	34
Recording blank sections	35
Checking what's at the end of a disc	35
Monitoring a source	36
To establish the copy-bit (SCMS) setting ...	36
Erasing a CD-RW disc	37
When a non-finalized disc is loaded	37
When a finalized disc is loaded	38
Reinitializing a disc	38

7 Additional Information

Understanding display messages	39
Troubleshooting	40
Display messages relating to playback ...	40
Display messages relating to recording ...	41
Specifications	43

Features of the CDR-830 BurnIT CD recorder

Create your own audio CDs

The HHB BurnIT offers a high-quality and affordable way to burn your own audio CDs. Create original recordings, or assemble professional compilations from existing source material.

The CD text feature of the CDR-830 allows you put text information on your recordings to easily identify and select from the contents.

Make digital recordings from any source

The CDR-830 can accept digital input via optical or coaxial cable, meaning that you can connect it to almost any other digital audio component. Also, thanks to the built in sampling rate converter, you can make direct digital recordings from many different sources such as DAT (32kHz up to 48kHz), as well as CD and MD (both 44.1kHz). A sampling rate converter 'through' feature (for 44.1kHz sources only) enables you to record HDCD and DTS encoded CDs too. Analog sources are also catered for with the analog line inputs, suitable for connection to standard unbalanced line level connections.

Use both ordinary recordable CDs and rewritable CDs

Ordinary recordable CDs (CD-R) can be recorded on just once, but the relatively cheap cost of blank discs and the ability to play the recorded discs on any ordinary CD player* make them ideal for many applications. Compact Disc Rewritable, or CD-RW, is a more recent type of recordable CD that allows erasing and re-recording of the disc. Although the blank discs are more expensive, this ability to use the discs over and over gives them the edge in terms of flexibility over CD-R*.*.

* While most CD players should have no problems with CD-R discs, if the laser pickup is dirty (from prolonged exposure to tobacco smoke, for example), the player may not be able to read some CD-R discs.

**At the time of writing, many ordinary CD players cannot play CD-RW discs. Check in the instructions that came with the player for compatibility.

Checking what's in the box

Make sure that you've received the following supplied accessories with your CDR-830 CD Recorder:

- | | |
|---------------------------|-------------------------------|
| 1 Two sets of audio cords | 4 Two 'AA' size R6P batteries |
| 2 AC power cord | 5 HHB CD-R 80 disc |
| 3 Remote control unit | |

- Also included in the box is your Registration card, this instruction manual, the HHB BurnIT brochure, and the HHB BurnIT Quick reference guide.

Using this manual

This manual is for the CDR-830 CD Recorder. It is split into two sections: the first shows how to set up the CD recorder; the second takes you through each stage of operation. Set up, which starts here, shows you how to get your new CD recorder up and running with the rest of your audio equipment.

In the second section of the manual, starting on page 16, you'll learn how to use the various features of the recorder.

The final part of the manual provides reference information on display messages you might encounter during use, a troubleshooting section, and technical specifications.

Hints on installation

We want you to enjoy using the CDR-830 for years to come, so please bear in mind the following points when choosing a suitable location for it:

Do...

- ✓ Use in a well-ventilated location.
- ✓ Place on a solid, flat, level surface, such as a table or shelf. Ideally rack mount the recorder in a 19" rack.

Don't...

- ✗ Use in a place exposed to high temperatures or humidity, including near radiators and other heat-generating appliances.
- ✗ Place on a window sill or other place where the player will be exposed to direct sunlight.
- ✗ Use in an excessively dusty or damp environment.
- ✗ Place on an unstable surface, or a surface is not large enough to support all four of the unit's feet.

Putting the batteries in the remote control

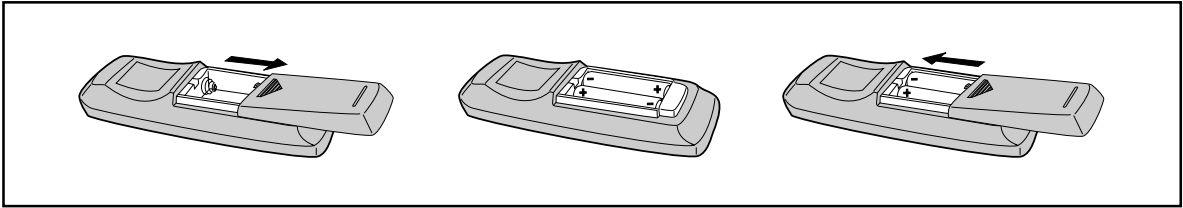

- Turn over the remote control, then press and slide the battery compartment cover off.
- Put in the batteries supplied, taking care to match the plus and minus ends of each battery with the markings inside the compartment.
- Slide the cover back on, and your remote is ready for use.

Caution!

Incorrect use of batteries can result in hazards such as leakage and bursting. Please observe the following:

- Don't mix new and old batteries together
- Don't use different kinds of battery together—although they may look similar, different batteries may have different voltages.
- Make sure that the plus and minus ends of each battery match the indications in the battery compartment.
- Remove batteries from equipment that isn't going to be used for a month or more.
- When disposing of used batteries, please comply with governmental regulations or environmental public institution's rules that apply in your country or area.

Avoiding condensation problems

Condensation may form inside the player if it is brought into a warm room from a cold environment, or if the temperature of the room rises quickly. Although the condensation won't damage the player, it may temporarily impair its performance. For this reason you should leave it to adjust to the warmer temperature for about an hour before switching on and using.

Care and maintenance

Cleaning external surfaces

Before cleaning turn off and disconnect the unit from the power outlet. To clean, wipe with a soft, dry cloth. For stubborn dirt, wet a soft cloth with a mild detergent solution made by diluting one part detergent to 5 or 6 parts water, wring well, then wipe off the dirt. Use a dry cloth to wipe the surface dry. Do not use volatile liquids such as benzene or thinners which may damage the surfaces.

Moving the unit

If you need to move the unit, first switch it off and unplug from the wall outlet. **Never lift or move the unit during playback or recording**—the disc rotates at a high speed and may be damaged.

Storing optical cable

When storing optical cable, coil loosely as shown at right. The cable may be damaged if bent around sharp corners.

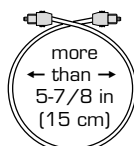

Handling discs

When holding CDs of any type, take care not to leave fingerprints, dirt or scratches on the disc surface. Hold the disc by its edge or by the center hole and edge. Damaged or dirty discs can affect playback and/or recording performance. Take care also not to scratch the label side of the disc. Although not as fragile as the recording side, scratches can still result in a disc becoming unusable.

Should a disc become marked with fingerprints, dust, etc., clean using a soft, dry cloth, wiping the disc lightly from the center to the outside edge. If necessary, use a cloth soaked in alcohol, or a commercially available CD cleaning kit to clean a disc more thoroughly. Never use benzene, thinners or other cleaning agents, including products designed for cleaning vinyl records.

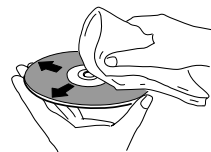

Wipe lightly from the center of the disc using straight strokes.



Don't wipe the disc surface using circular strokes.

1 Before you start

Storing discs

Although CD, CD-R and CD-RW discs are very durable, you should still take care to handle and store discs correctly. When you're not using a disc, return it to its case and store upright. Avoid leaving discs in excessively cold, humid, or hot environments (including under direct sunlight).

When labeling discs, use a felt-tip pen sold for marking CDs. Use only labels that are designed specifically for CD use. Don't glue paper or put other stickers onto the disc, or use a pencil, ball-point pen or other sharp-tipped writing instrument. These could all damage the disc.

Discs to avoid

This recorder is not compatible with 90-minute CD-Rs or High Speed CD-RW discs. Do not use either type of disc with this recorder.

CDs spin at high speed inside the player during playback and recording. If you can see that a disc is cracked, chipped, warped, or otherwise damaged, don't risk using it in your CD recorder or player—you could end up damaging the unit.

The CDR-830 is designed for use with conventional, fully circular CD's only. Use of shaped CD's is not recommended for this product. HHB disclaims all liability arising in connection with the use of shaped CD's.

CD lens cleaner

The compact disc recorder's pickup lens should not become dirty in normal use, but if for some reason it should malfunction due to dirt or dust, consult your nearest HHB authorized service center. Although lens cleaners for compact disc recorders are commercially available, we do not recommend using them since some may damage the lens.

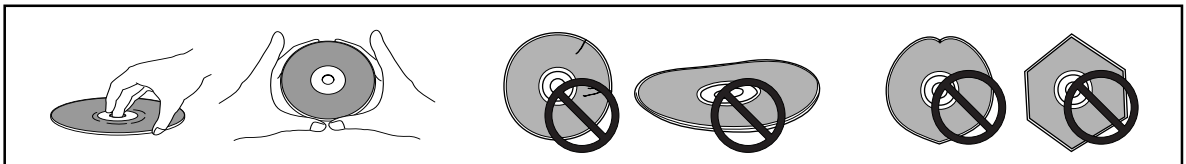

About CD, CD-R and CD-RW discs

The CDR-830 is compatible with four types of compact disc:

Playback-only CDs

This unit will playback any ordinary audio CDs carrying the Compact Disc Digital Audio mark shown right.



CD-Recordable discs

Recordable CDs, or CD-R, carry the mark shown right, and are 'write once'. This means that having recorded something on the disc it is permanent—it can't be re-recorded or erased.



CD-Rewritable discs

Rewritable CDs, or CD-RW, carry the mark shown right. As the name indicates, you can erase and re-record material on these discs so that they can be used over and over again.



CD TEXT discs

CD Text discs, carry the mark shown right. These are commercially available discs that will display the disc title, artist name, and track titles of the disc when played in a CD text compatible player.



Your HHB CDR-830 Professional CD Recorder is designed to operate with a broad range of CD-R or CD-RW media. However, for consistently high quality results and superior archiving stability, we recommend that you ask your dealer for these commercially available CD-R or CD-RW discs from HHB.

CDR 74 Gold	CDR 74 Silver
CDR 74 Silver P	CDR 80 Silver
CDRW 74	CDRW 80

You may also use consumer audio CD-R and CD-RW discs with this recorder.

Recording and finalizing discs

Unlike other recording media, recordable CDs have a number of distinct states, and what you can do with a disc depends on the current state of the disc. The figure below shows the three states—blank, partially recorded, and finalized—and summarizes what's possible (✓) and impossible (✗) in each.

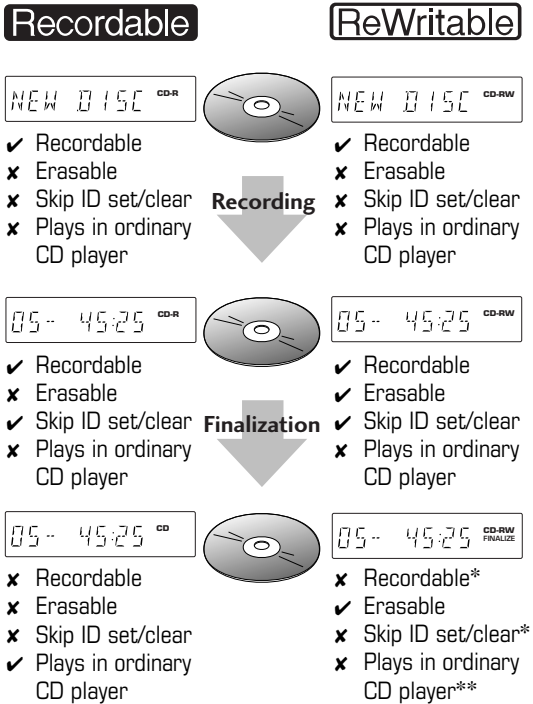

* Once the CD-RW has been erased, it becomes recordable again and skip IDs can be set and cleared.

** In general, current CD players cannot play CD-RW discs. However, this situation will change in the future.

The process of finalization fixes the contents of a CD-R in place permanently by creating a Table of Contents (TOC, for short) at the beginning of the disc which tells other players exactly what's on the disc and where to find it. See **Finalizing a disc** on page 26 for more details on finalization.

Recording copyright material

WARNING: Recording of CD's or other material protected by copyright can be unlawful, and the CDR830 is not supplied for such purposes. Please ensure that this unit is not used for any infringement of copyright law. HHB accepts absolutely no responsibility regarding the use of this product for unlawful purposes.

Keep in mind the following when using the remote control unit:

- Make sure that there are no obstacles in between the remote and the remote sensor on the unit.
- Use within the operating range and angle, as shown in the diagram below.
- Remote operation may become unreliable if strong sunlight or fluorescent light is shining on the unit's remote sensor.
- Remote controllers for different devices can interfere with each other. Avoid using remotes for equipment located near this unit while using the CDR-830.
- Replace the batteries when you notice a fall off in the operating range of the remote.

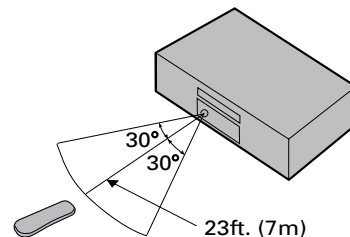

2 Connecting up

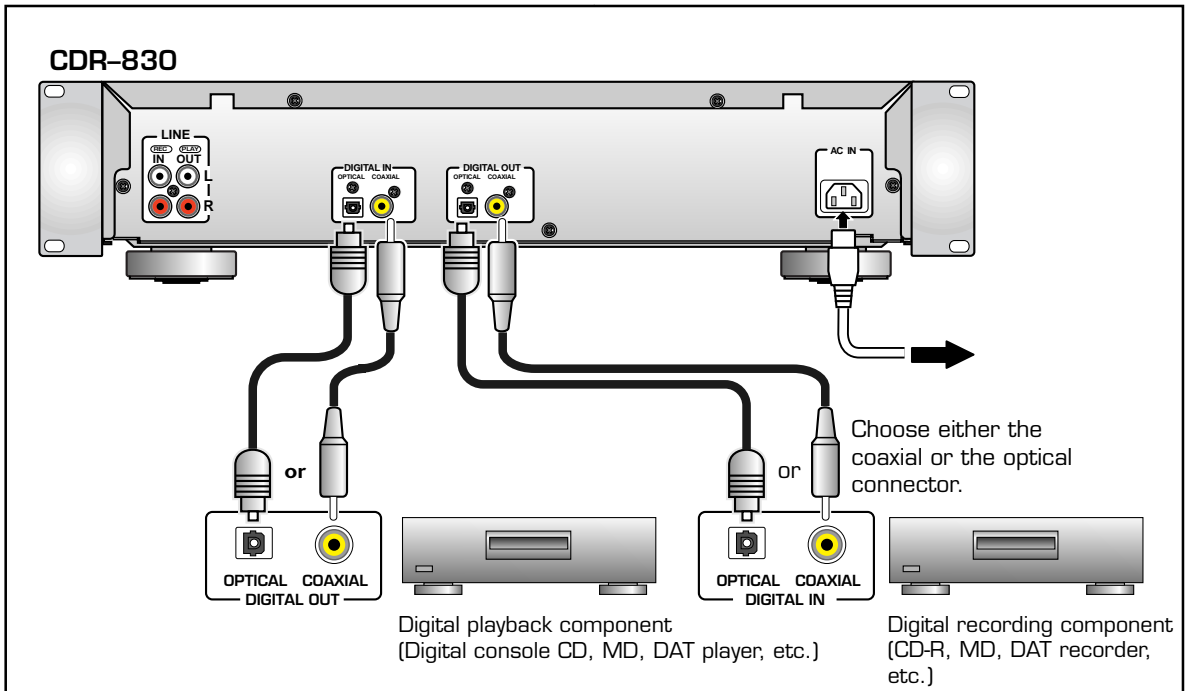

Before making or changing the connections, switch off the power and disconnect the power cord from the AC outlet.

Please ensure that if you are using the coaxial digital connections that 75 ohm video type cable is used.

Connecting up for digital playback & recording

The diagrams on these pages show possible connections with various other components in your system. Before you start connecting your system, make sure that all the components are switched off and disconnected from the wall outlet.

About optical and coaxial jacks

The CDR-830 has both optical and coaxial jacks for both digital input and output. There's no need to connect both, but since some equipment has only one type of connector—and you can only connect like with like—having both types on this unit can be an advantage.

To use the optical jack, you'll need an optical cable. These are readily available at audio dealers. When buying, check that the cable is no longer than 3m.

Pull out the dust cap and store it in a safe place for future use. Check that both optical plug and socket are free from dust—if necessary, clean with a soft, dry cloth. The optical lead will only go in one way, so match up the jack and the plug before inserting fully.

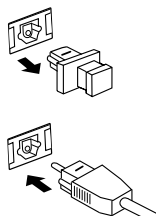

When connecting optical leads, take care not to bend the cable around sharp corners as this can damage the cable. Likewise, when storing optical cable, coil loosely (as shown on page 7).

If you're using one of the coaxial-type digital connectors you'll need a lead with an RCA/ phono plug at each end. Please only use digital audio cables, not normal audio interconnects.

Using the digital inputs

To make direct digital recordings on the CDR-830 you'll need to connect the digital output of a source (like a CD, MD, or DAT player) to one of the digital inputs on this unit. To make recordings from analog sources (like an analog tape deck) connect the outputs of your analog source to the line inputs of the CDR-830—see the following page for more detail.

Using the digital outputs

If you have another digital recorder, such as a MD or DAT recorder, you might want to use the CDR-830 as a digital source. In this case, connect one of the digital outputs of the CDR-830 to a similar digital input on your other digital recorder.

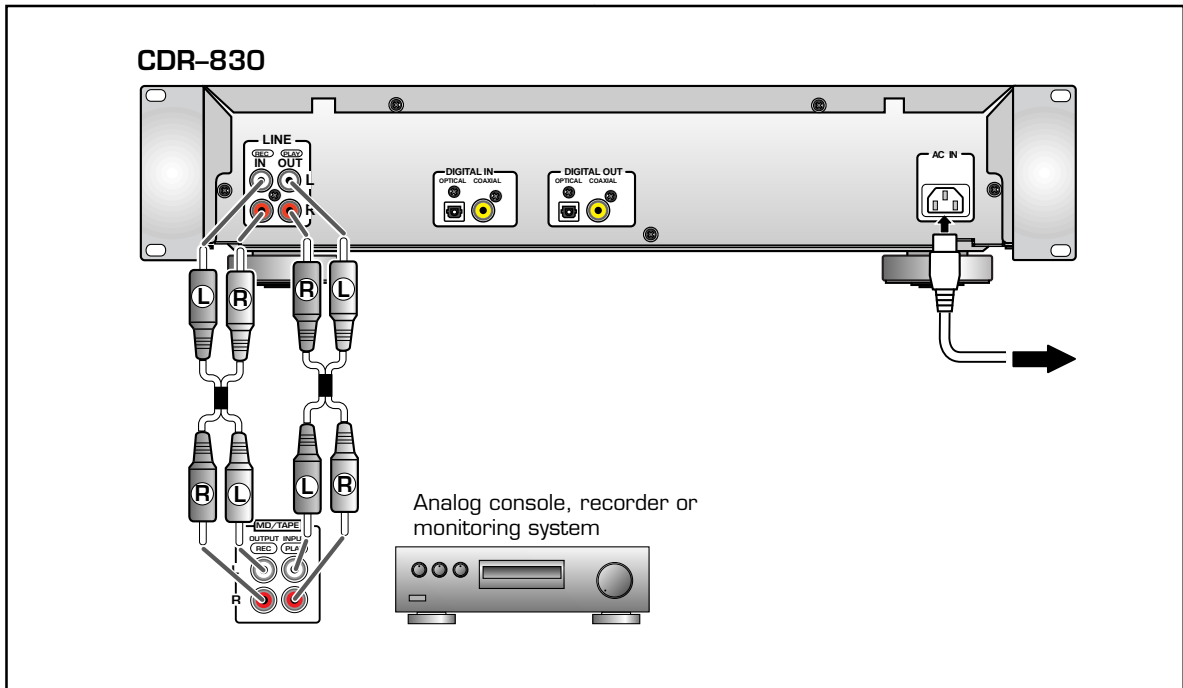

Connecting up for analog playback & recording

Before you start, make sure that all the components are switched off and disconnected from the wall outlet.

Next, connect this unit to your mixer, recorder or monitoring system using the two sets of supplied audio leads.

The input to the CDR-830 must be connected to the output of the external device - console etc. and the output of the recorder connected to the monitoring path of the console, or other monitoring device.

POWER-CORD CAUTION

Handle the power cord by the plug part. Do not pull out the plug by tugging the cord, and never touch the power cord when your hands are wet, as this could cause a short circuit or electric shock. Do not place the unit, a piece of furniture, or other object on the power cord or pinch the cord in any other way. Never make a knot in the cord or tie it with other cords. The power cords should be routed so that they are not likely to be stepped on. A damaged power cord can cause a fire or give you an electric shock. Check the power cord once in a while. If you should find it damaged, ask your nearest HNB authorized service center or your dealer for a replacement.

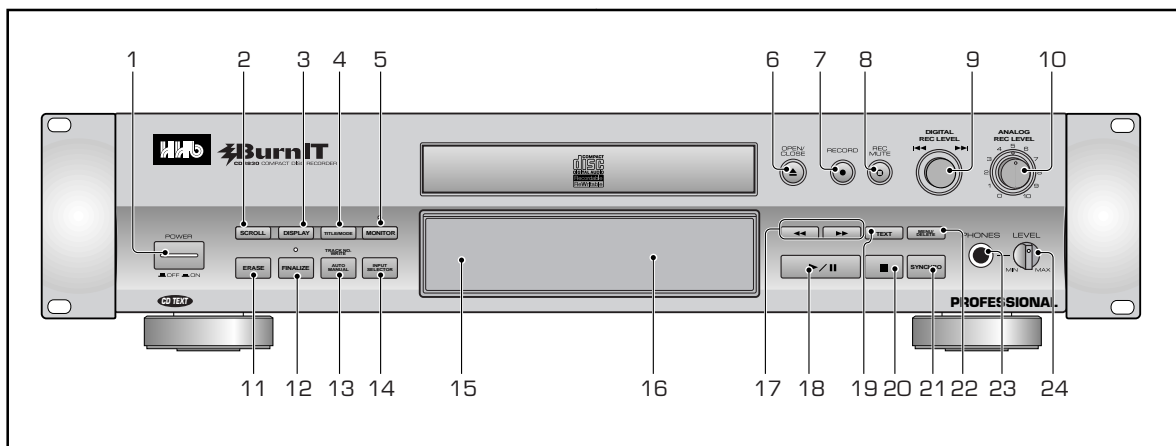

Front panel

- 1 POWER switch (p.15)**
Switches power to the unit on and off.
- 2 SCROLL (p. 16)**
Press to scroll through long names in CD text.
- 3 DISPLAY (p. 17)**
Switches the display mode (elapsed track time, remaining track time, total disc playing time, etc.)
- 4 TITLE/MODE (p.16,30)**
Press to switch between display modes (disc title, artist name, track title) (p.16), and between upper- and lower-case characters while using CD text (p.30).
- 5 MONITOR (p.23-25,36)**
Press to monitor the selected input and display digital source information. Indicator lights up to remind you when you are monitoring.
- 6 OPEN/CLOSE ▲ (p. 15)**
Press to open or close the disc tray.
- 7 RECORD ● (p.22-25)**
Press to enter record-pause mode for setting input levels, etc.
- 8 REC MUTE ○ (p.35)**
Records a blank section on a disc (for space between tracks, etc.)
- 9 DIGITAL REC LEVEL / ◀▶▶▶ (Jog dial)**
Turn the jog dial to: set the digital recording level (p.23); skip tracks (p. 15); select options in the menu (p.23,25,33,34); cycle through characters in CD text (p.30); select tracks to erase (p.37-38).
Push the jog dial to: start playback (stop mode only) (p. 15); input track numbers (during programming) (p.27); select characters in CD text (p.30); confirm menu settings (p. 16).
- 10 ANALOG REC LEVEL (p.24)**
Sets the recording level for analog-input recording.
- 11 ERASE (p.37-38)**
Press to start erasing tracks, or to re-initialize a disc.
- 12 FINALIZE (p.26)**
Press to start the disc finalization process (to make recordable CDs playable on ordinary CD players). Indicator lights up during finalization.
- 13 AUTO/MANUAL (p.33-34)**
Switches between automatic and manual track numbering when recording a disc.
- 14 INPUT SELECTOR (p.19-24,36)**
Switches between the analog, optical digital and coaxial digital inputs.
- 15 Remote sensor (p.9)**
- 16 Character display (p. 14)**
- 17 ◀▶▶▶ / REC BALANCE (p. 15,25,30)**
Press and hold for fast-reverse and fast-forward playback (p. 15). Use when recording to set left and right input levels (p.25). Use to move cursor back and forth across character display while using CD text (p.30).
- 18 ▶|| (p. 15,26,37-38)**
Press to play, pause, or resume playing a disc. Also use to start recording from record-pause mode and to start finalization and erasing.
- 19 TEXT (p.30-32)**
Use to cycle through CD text naming options.
- 20 ■ (p. 16,19-22)**
Press to stop playback or recording.
- 21 SYNCHRO (p.19-21)**
Press to start recording on detection of an input signal.
- 22 MENU/DELETE (p. 16,23,25,30,33,34,36)**
Press to cycle through the preference menu options(p. 16, 23, 25,33,34,36). Press to delete characters while editing CD text (p.30).
- 23 PHONES jack**
Plug in a pair of stereo headphones for private listening or monitoring.
- 24 LEVEL**
Use to adjust the phones volume.

Remote control

- 1 **○ REC MUTE (p.35)**
Records a blank section on a disc (for space between tracks, etc.)
- 2 **● REC (p.22–25)**
Press to enter record-pause mode.
- 3 **DISPLAY (p.17)**
Switches the display mode (elapsed track time, remaining track time, total disc playing time, etc.)
- 4 **TITLE/MODE (p.16,30)**
Press to switch between display modes (disc title, artist name, track title) (p.16), and between upper- and lower-case characters while using CD text (p.30).
- 5 **SCROLL (p.16)**
Press to scroll through long names in CD text.
- 6 **MARK / 10/0**
Press to choose symbol characters when using CD text. As a numeric key, this represents zero.
- 7 **MENU/DELETE (p.16,23,25,30,33,34,36)**
Press to cycle through the preference menu options. Press to delete characters while editing CD text.
- 8 **◀◀ (p.15)**
Press to skip backward tracks. Also performs those operations assigned to turning the jog dial (see page 12).
- 9 **Playback control (p.15–16,19–22) / ENTER**
▶ Press to play, or resume playing, a disc.
◀◀ and ▶▶ Press and hold for fast-reverse and fast-forward playback, and to move cursor position using CD text.
■ Press to stop playback or recording.
ENTER Confirm playback, recording, menu settings (p.16), and characters in CD text (p.30).
- 10 **←**
Press to skip backward index points.
- 11 **RANDOM (p.28)**
Press to start random playback.
- 12 **REPEAT (p.28)**
Use to set the repeat mode (current track, disc, or repeat off).
- 13 **PROGRAM (p.27)**
Use to program the playback order of tracks on a disc.

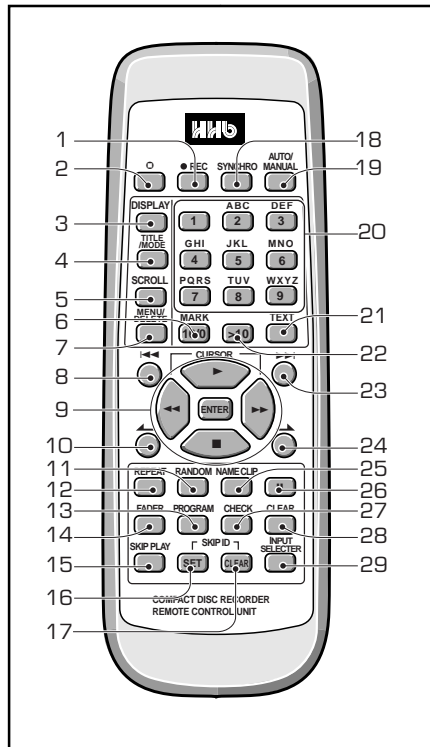

- 14 **FADER (p.28,34)**
Press to fade in or fade out during playback or recording.
- 15 **SKIP PLAY (p.28)**
Press to switch skip play on and off.
- 16 **SKIP ID SET (p.29)**
Instructs the player to skip a particular track on playback.
- 17 **SKIP ID CLEAR (p.29)**
Clears the above setting.
- 18 **SYNCHRO (p.19–21)**
Press to start recording on detection of an input signal.
- 19 **AUTO/MANUAL (p.33)**
Switches between automatic and manual track numbering when recording a disc.
- 20 **Number / Letter buttons (p.16,27,30)**
Use to jump directly to track numbers for playback, selecting track numbers for editing / programming, and selecting letters when using CD text.
- 21 **TEXT (p.30–32)**
Use to cycle through CD text naming options.
- 22 **>10 (p.16,27)**
Use to select track numbers over 10.
- 23 **▶▶ (p.15)**
Press to skip forward tracks. Also performs those operations assigned to turning the jog dial (see page 12).
- 24 **→**
Press to skip forward index points.
- 25 **NAME CLIP (p.32)**
Press to copy the current CD text to the recorder's memory.
- 26 **|| (p.15,22,26,37–38)**
Press to pause playback or recording and start finalization and erasing.
- 27 **CHECK (p.27)**
Press repeatedly to step through the program playlist.
- 28 **CLEAR (p.27)**
Press to clear the last track in a programmed playlist.
- 29 **INPUT SELECTOR (p.19–24,36)**
Switches between the analog, optical digital and coaxial digital inputs.

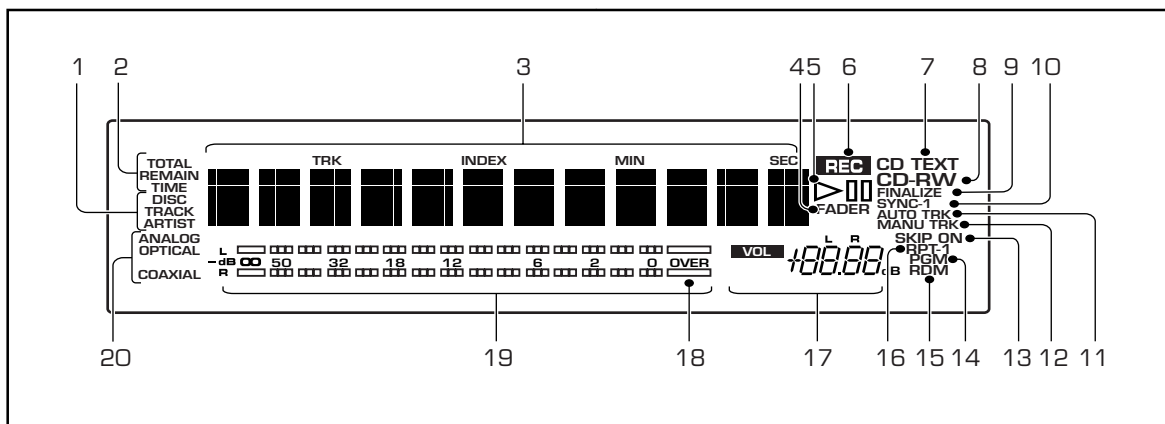

Display

1 CD text indicators (p. 16)

DISC Lights up when disc information is displayed.

TRACK Lights up when track information is displayed.

ARTIST Lights up when artist information is displayed.

2 TOTAL / REMAIN / TIME (p. 17)

Indicates whether the current displayed time is elapsed, remaining, or total time for a disc or individual tracks.

3 Message/time display

4 FADER (p. 28, 34)

Blinks during fade in or fade out.

5 ► (p. 15–16)

Lights up during playback.

■ (p. 15, 22)

Lights during play- or record-pause.

6 REC (p. 22–25, 34)

Lights up to when recording or record-paused. Blinking display indicates record muting.

7 CD TEXT (p. 15, 30, 31)

Lights if the CD currently loaded contains CD text.

8 CD / CD-R / CD-RW (p. 15)

Indicates the type of disc currently loaded.

9 FINALIZE (p. 21, 26)

Lights up if the CD-RW currently loaded has been finalized. Also blinks during automatic finalization recording (p. 21, 26).

10 SYNC / SYNC-1 (p. 19–21)

Lights up when the recorder is in automatic synchro recording mode.

11 AUTO TRK (p. 33)

Lights when automatic track numbering is on during recording.

12 MANU TRK (p. 34)

Lights up when manual track numbering is on during recording.

13 SKIP ON (p. 28)

Lights up to indicate that a disc contains skip IDs. When setting or clearing skip IDs, the word **SKIP** blinks.

14 PGM (p. 27)

Lights up when program-play is active.

15 RDM (p. 28)

Lights up when random-play is active.

16 RPT / RPT-1 (p. 28)

Lights up when repeat play is active.

17 Recording level balance (p. 16, 23, 25)

Displays the digital recording volume. If the balance has been changed, the indicator (**L** or **R**) of the louder channel lights up. Both indicators light when the balance is unchanged. Track numbers are displayed while using CD text.

18 OVER indicator (p. 24)

Indicates that the input signal overloaded the disc during recording.

19 Recording level meter (p. 19–24)

Displays the input level during recording, or the recorded level during playback.

20 ANALOG (p. 19–24, 37)

Lights when the analog input is selected.

OPTICAL (p. 19–24, 37)

Lights when the optical digital input is selected.

COAXIAL (p. 19–24, 37)

Lights when the coaxial digital input is selected.

Switching on for the first time

The next few pages take you through switching on the CDR-830, playing discs, and doing some basic recording. Before proceeding with this section you should have at least connected your recorder to a monitor system. (If you haven't, turn to pages 10-11 for more on connecting the CDR-830 to other items in your system.)

1 Switch the POWER to ON.

The record indicator flashes, and the main display panel lights up.

- Also make sure that you have connected the output of the CDR-830 to a monitor system.

2 Press OPEN/CLOSE ▲ to open the disc tray.

3 Load a pre-recorded audio CD.

Place the disc in the disc tray label-side up.

- The disc tray has guides for both CD singles (8cm) and regular CDs (12cm). Do not use an adaptor when playing CD singles: it could damage the recorder.

- Never load more than one disc at a time.

4 Press OPEN/CLOSE ▲ to close the disc tray.

Once the recorder has found out what is on the disc, the display will show track and disc information or, depending on the disc, CD text.

If the disc does not contain CD text, you should see a display that looks something like this:

Number of tracks on disc
Total playing time of disc

03
45:37
CD

Indicates a pre-recorded disc

- Pressing ► (►/||) on the front panel will also close the disc tray (but you won't see the above display).

If the disc contains CD text, the CD TEXT indicator lights up and the entire disc title automatically scrolls across the display. The first 12 characters of the disc title remain, as seen in the display below:

CD TEXT
CD
GREATEST HIT

You can switch CD text information displays by pressing TITLE/MODE.

See page 16 for more on CD text displays.

Pressing DISPLAY allows you to switch to the disc and track time information displays.

See page 17 for more on time displays.

5 Press ► to start the disc playing.

Pressing ►/|| or the jog dial on the front panel also starts playback.

6 To pause playback, press || (or ►/|| again).

To resume playback, press either || again, or ► (►/||). The recorder only remains paused for 10 minutes, then enters stop mode.

7 To fast-reverse or fast-forward, press and hold ◀◀ or ▶▶.

8 To skip back or forward to another track, press ◀◀ or ▶▶ (on the front panel, turn the jog dial).

Pressing ▶▶ once skips to the start of the next track on the disc. Further presses take you to subsequent tracks.

Pressing ◀◀ once takes you to the beginning of the current track. Further presses skip to the start of previous tracks.

You can use ◀◀ or ▶▶ while the disc is paused or stopped as well. The track number changes while the disc remains paused/stopped.

9 To skip back or forward index markers, press ◀ or ▶ on the remote control.

Because most CDs don't have index markers, you will generally see 01 in the index display for each track.

10 To stop playback, press ■.

Take out the CD from the disc tray before switching off the unit.

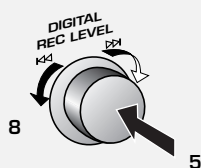
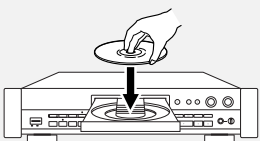
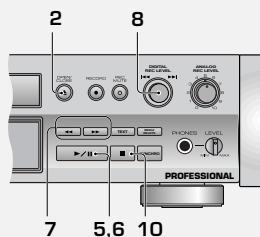
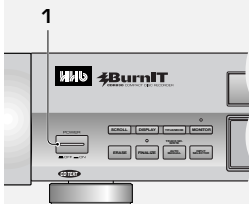
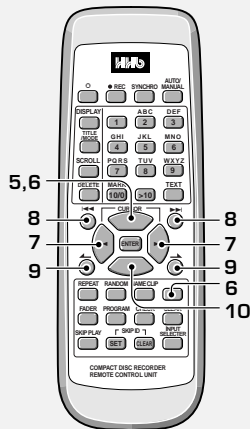

4 Getting Started

Number buttons

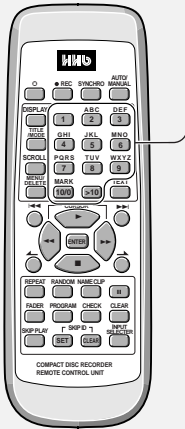

MENU/
DELETE

TITLE/MODE

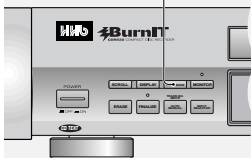

TITLE/MODE

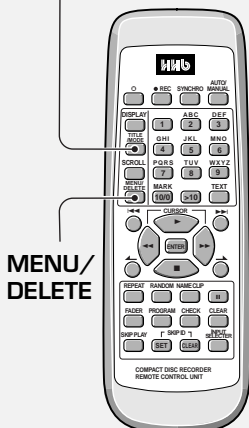

MENU/
DELETE

Selecting tracks directly

If you want to start directly from a track other than the first, just enter the track number from the remote control. If you do the same thing during playback, the recorder immediately jumps to that track on the disc.

- **While a disc is stopped, paused or playing, enter the track number you want to play.**

The recorder jumps directly to that track. If the recorder was stopped, the track then starts playing.

For track numbers 1 to 10, use the corresponding number button.

For track numbers over 10, press the >10 button, then enter the track number. For example, to select track 28:



Using the menu features

Several features of the CD recorder can be accessed by using the MENU/DELETE key. This menu is like a selection of preferences that will stay in memory even if the system is turned off (see note below). The jog dial cycles you through the features listed below (refer to the page numbers listed to set your preferences in the menu).

- Digital volume (p.23)
- Balance (p.25)
- Silence threshold for auto track numbering (p.33)
- Time increment recording (p.34)
- Fade length (p.34)
- Copy-bit (SCMS) setting (p.36)

Note: The time increment will default to **OFF** when: recording is stopped; auto track numbering is turned off; power is switched off. All settings will revert to factory defaults if the recorder is reset (p.26).

Showing CD text information

If the CD contains text information, you can see this in the display during both playback and when the disc is stopped. The TITLE/MODE button switches between the different text displays. When a disc with text is loaded into the recorder, the entire disc title automatically scrolls across the display. The first 12 characters of the disc title remain. Press SCROLL at any time to see the full title scroll across the display.

- **During playback, press TITLE/MODE to switch the display.**

There are three different displays. Press TITLE/MODE repeatedly to switch between them:

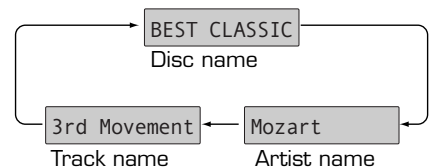

- **While stopped, press TITLE/MODE to switch the display.**

There are two different displays. Press TITLE/MODE repeatedly to switch between them:

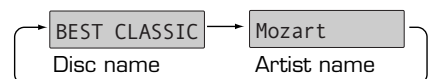

Showing disc information

The CDR-830 can display various kinds of disc and track information during both playback and recording. The **DISPLAY** button switches between the different time display modes. Additionally, while stopped, individual track information is available from the track skip buttons (◀◀ and ▶▶), or by turning the jog dial.

- **During playback, press DISPLAY to switch the display mode.**

There are three different displays. Press **DISPLAY** repeatedly to switch between them:

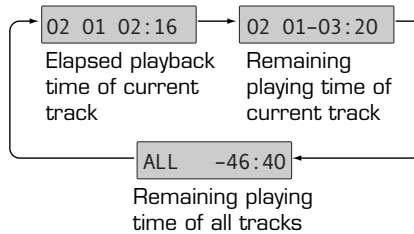

- **During recording, press DISPLAY to switch the display mode.**

There are two different displays. Press **DISPLAY** repeatedly to switch between them:

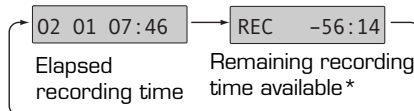

- **While stopped, press DISPLAY to switch the display mode.**

There are two different displays. Press **DISPLAY** repeatedly to switch between them:

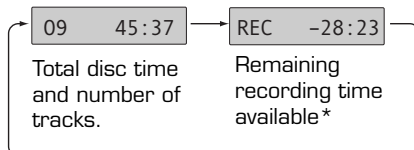

* Although compatible with 80 minute discs, the remaining recording time display will not accurately show 80 minutes for blank discs.

Introduction to CD recording

The CDR-830 is designed to let you make extremely high quality digital recordings onto recordable compact discs. For flexibility, you can use either rewritable discs (CD-RW) or write-once discs (CD-R). For more general information on the discs you can and can't use with this recorder, see About CD, CD-R and CD-RW Discs on page 8. The following overview gives you some idea of what the CDR-830 is capable of, and also provides guidance on what to avoid and things to be careful of when recording. We strongly recommend that you read these pages fully before proceeding to the more detailed instructions on the following pages.

Digital recording restrictions

This unit has been designed exclusively for recording and playback of audio discs—you can't record other CD formats, such as computer CD-ROMs or Dolby Digital (AC-3).

If you record from a disc format such as CD+graphics, Video-CD, or other format that includes both digital audio and video or text, you will only be able to record the audio part of the disc.

In addition to standard audio CDs, this recorder will record DTS encoded audio CDs and HDCD format CDs (in this case, the recording level must be set to **0dB**).

Almost all commercial digital source material is protected by copyright laws, and many CDs use copy control flags to limit digital recording of a source to one generation only. However, as the CDR-830 is a professional recorder, the status of the source copy control flags is ignored, and the status of the flag written to disc is adjustable.

This facility is only for professional use and must never be used to enable infringement of copyright.

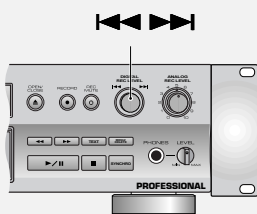
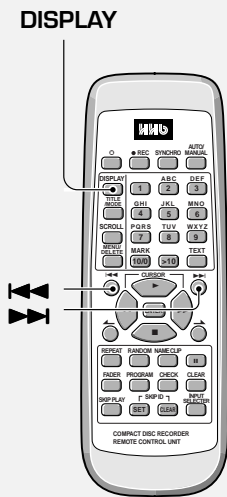
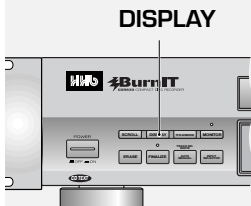

Recording modes

The recorder is equipped with a set of analog input terminals, as well as both optical and coaxial digital inputs. This means that the CDR-830 is compatible with almost all audio sources—analogue or digital. It even has a built in sampling rate converter making it ideal for recording from 48kHz DAT or other digital source, which might be at a sampling rate different to that of CD. Since CDs are always recorded at a sampling rate of 44.1kHz, sample rate conversion is completely automatic—if the recorder senses a digital signal at either 32 or 48kHz, it will convert it to 44.1kHz. Note that this recorder can't convert 96kHz digital sources (such as some DAT tapes and DVD discs).

Miscellaneous information

- The minimum recordable time is four seconds.
- Usually, track numbers are recorded onto the disc automatically when recording. If you decide to switch off this feature (for example, when you're recording from a digital broadcast), be sure to input track markers as recording is taking place—you can't add them after recording is complete. See page 33 for more on manual and automatic track numbering.
- The maximum number of tracks on a disc is 99.

Digital recording from DAT

If you're recording a DAT tape that was recorded using the DAT machine's auto ID function, the IDs on the tape may be slightly after the beginning of the actual recording. This can cause problems for the CD recorder:

- The start of the track may not be recorded.
- The track number will be recorded on the disc after the start of the track.
- The beginning of the next track on the DAT is unintentionally recorded.

To avoid these problems, we recommend recording start IDs on the DAT manually, if possible. If this is not possible, or if there are no start IDs on the DAT, we recommend using manual track numbering while recording to CD to ensure that new tracks are starting in the right places. Refer to the instructions for your DAT recorder for more information.

You might also encounter problems if you try to synchro-record all tracks from a DAT that is set to program play. If you want to record a DAT in program play mode, use the 1-track synchro recording mode—see page 19 for how to do this.

Digital signal interruptions

Sources of signal interruption include power or source component failure, accidental disconnection of the interconnect cord, and interruption of digital broadcasts. In all these cases, if the signal resumes within about five seconds, the result will just be a blank section on the disc. If the interruption is longer than five seconds, the recorder displays the error message: **DIN UNLOCK** and recording is paused.

Power interruptions

Never switch off the CDR-830 while it's recording, or while the display shows **PMA REC** (Program Memory Area Recording). If there's a power failure, or you accidentally disconnect the power from the wall outlet while recording is in process, you may lose at least part of the recording.

After recording, always remove the disc from the recorder before switching the power off. Failure to do this could result in you losing some of the recorded material on the disc.

Recording one track from a source

If you want to record just a single track, or a few selected tracks, from a digital (CD, MD, DCC or DAT) or an analog source, the recorder can start and stop automatically. With digital recording, there's no need to worry about recording levels—you'll get a perfect digital copy of the original (if you want to change the digital recording level, see page 23).

If you are recording from a noisy analog source, such as an old recording, or from a source with long quiet sections, the recorder may not recognize the end of the track. In this case, we recommend using manual recording (see page 22).

1 Load a CD-R or CD-RW disc.

Check the display to make sure that there's enough space on the disc for what you want to record.

2 Press INPUT SELECTOR to choose an input.

Pressing **INPUT SELECTOR** repeatedly switches the active input:

Analog - Optical - Coaxial

The recorder's display indicates the current input.

3 Make sure that the source is not playing, then press SYNCHRO.

Press **SYNCHRO** repeatedly to change the recording mode, and to select SYNC-1.

Synchro recording will not work if the source is already playing!

The **SYNC-1** indicator will start to blink when the recorder is ready.

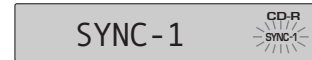

The display shows the 1-track sync mode, with the **SYNC-1** indicator blinking to show that recording can start.

4 Play the source.

The recorder starts recording automatically.

5 The recorder pauses recording after recording one track.

If you're recording a CD or MD, recording pauses automatically when the track changes or there is more than five seconds of silence on the source.

If you're recording from DCC or DAT tape, recording pauses when the recorder encounters a new start ID or there is more than five seconds of silence on the source. (See also **Digital recording from DAT** on page 18.)

If you're recording from analog, recording pauses automatically when there is more than two seconds of silence on the source.

6 If you're done, press ■.

To record further tracks, simply repeat steps 3 to 5.

After pressing **■**, the display shows **PMA REC** while it records the track information to the disc.

Note: If you find that synchro recording does not seem to work, see the troubleshooting section on pages 40–42 for possible remedies.

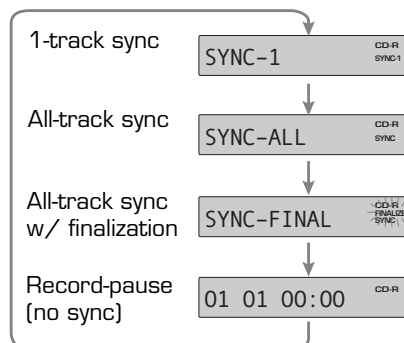
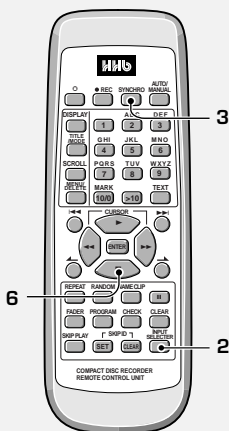
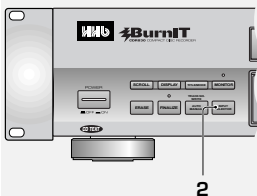
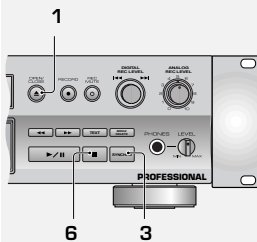

Recording all tracks from a source

If you want to copy all the tracks from a source, use this mode. Like the 1-track synchro recording mode, the recorder starts and stops automatically. When recording from MD or CD, you can play the source in either normal play mode, or program play if you'd like the recorded tracks in a different order to the original. We do not recommend recording from a DAT in program play mode—use the 1-track synchro recording mode if you want to record the tracks in a different order.

If you are recording from a noisy analog source, such as an old recording, or from a source with long quiet sections, the recorder may not recognize the end of tracks. In this case, you can still use this mode, but it may be better to use manual track numbering (see page 33).

1 Load a CD-R or CD-RW disc.

Check the display to make sure that there's enough space on the disc for what you want to record.

2 Press INPUT SELECTOR to choose an input.

Pressing INPUT SELECTOR repeatedly switches the active input:

Analog - Optical - Coaxial

The recorder's display indicates the current input.

3 Make sure that the source is not playing, then press SYNCHRO twice.

Press SYNCHRO repeatedly to change the recording mode and select SYNC-ALL.

Synchro recording won't work if the source is already playing!

The recorder goes into all-sync record pause and the **SYNC** indicator starts to blink.

SYNC-ALL



The display shows the all-track sync mode, with the **SYNC** indicator blinking to show that recording can start.

4 Play the source.

The recorder starts recording automatically.

5 After recording all tracks from the source, the recorder goes into record-pause.

After the recorder encounters about five seconds of continuous silence, it assumes the end of the source has been reached and goes into record-pause and the display shows the **SYNC ALL** message again.

Be careful: If the recorder detects another signal or start ID (DAT or DCC) it will start recording again!

- The recorder will enter record-pause if the digital signal is interrupted for more than 5 seconds—see *Digital signal interruptions* on page 18.

6 Press ■ to finish recording.

After pressing ■, the display shows **PMA REC** while it records the track information to the disc.

Note: If you find that synchro recording does not seem to work, see the troubleshooting section on pages 40-42 for possible remedies.

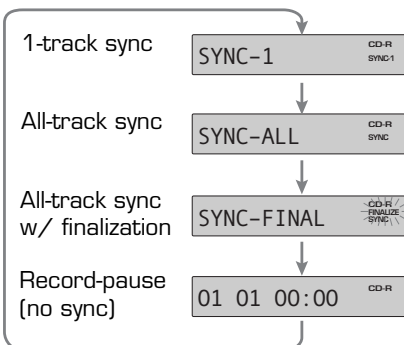
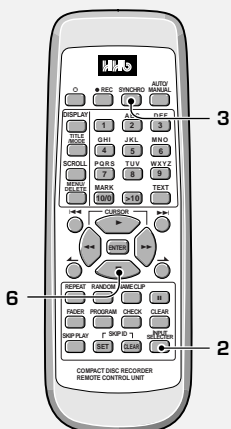
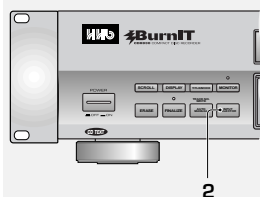
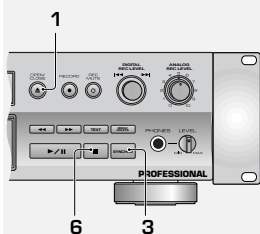

Automatically recording and finalizing a disc

This is a variation on all-track synchro recording on the previous page. After all tracks on the source material have been recorded, the recorder automatically finalizes the disc.

Note: Any interruptions in the digital input source signal may cause the recorder to enter record pause, which may inhibit the finalization of the disc.

1 Load a CD-R or CD-RW disc.

Check the display to make sure that there's enough space on the disc for what you want to record.

2 Press INPUT SELECTOR to choose an input.

Pressing **INPUT SELECTOR** repeatedly switches the active input:

Analog - Optical - Coaxial

The display indicates the current input.

3 Make sure that the source is not playing, then press SYNCHRO three times.

Press **SYNCHRO** repeatedly to change the recording mode and select **SYNC-FINAL**

The display shows all-track sync with finalization, with the **SYNC** and **FINALIZE** indicators blinking to show that recording can start.

Note: Please ensure that there are no long pauses in the source material, as this might cause the recorder to start the finalization process.

4 Play the source.

Recording starts automatically. If you press **SYNCHRO** during recording, the recorder will finish recording without finalizing the CD-R.

5 After recording all tracks on the source, the recorder starts finalizing the disc.

After the recorder encounters about five seconds of continuous silence, it assumes the end of the source has been reached and goes into all-sync record-pause.

Be careful: If the recorder detects another signal or start ID (DAT or DCC) it will start recording again!

If the recorder detects no signal for one minute, finalization starts (no more recording is possible after this so make sure that there aren't any spaces of more than one minute during the source you're recording). See **Automatically numbering tracks** on page 33 to set the silence threshold.

Finalization takes about two minutes, during which time none of the buttons are operative.

Never turn the power off during finalization!

- If a digital signal is interrupted, the recorder continues recording. However, if no signal has been detected within five seconds, the recorder pauses recording and will not finalize the disc—see **Digital signal interruptions** on page 18.

- If the recorder reaches the end of the disc, the recorder begins finalization.

Note: If you find that synchro recording does not seem to work, see the troubleshooting section on pages 40–42 for possible remedies.

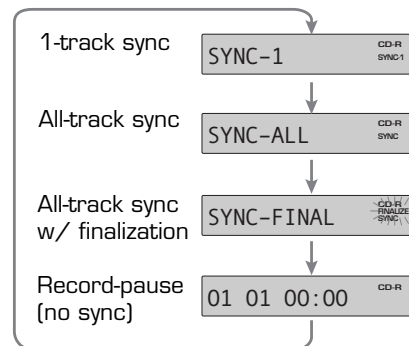
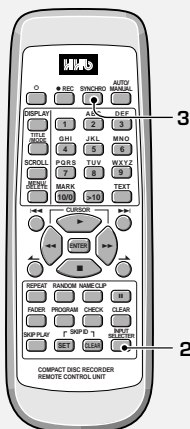
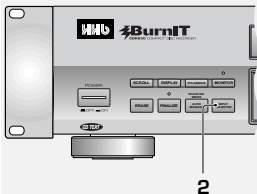
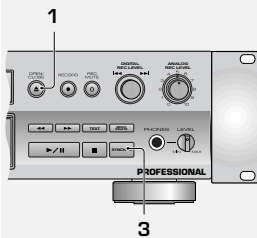

Synchro recording won't work if the source is already playing! The recorder goes into all-sync record pause and the **SYNC** and **FINALIZE** indicators start to blink.



4 Getting started

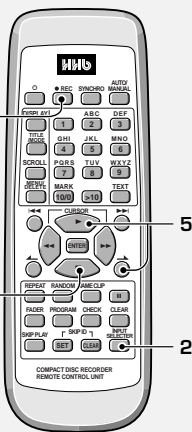
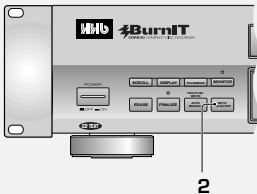
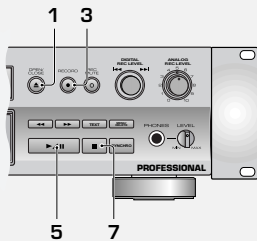

Manual recording

Use the manual recording method with a source where synchro recording is not suitable. For example, if you are recording from a digital source that does not have ID flags, synchro recording is not possible since there are no track numbers or start IDs to signal the start and end points of the recording. Manual recording is also useful with a noisy analog source, such as an old recording, or from a source with long quiet sections, where the recorder may not recognize the end of tracks.

1 Load a CD-R or CD-RW disc. Check the display to make sure that there's enough space on the disc for what you want to record.

2 Press INPUT SELECTOR to choose an input.

Pressing **INPUT SELECTOR** repeatedly switches the active input:

Analog - Optical - Coaxial

The recorder's display indicates the current input.

3 Press RECORD ● (● REC on the remote control).

The recorder goes into record-pause. (You can also press **MONITOR**.)

4 Start playing the source to check the signal.

If necessary, set the recording level (see page 23).

If the signal appears OK, stop the source.

5 Check that the time display reads 00:00, then press || or ► (►/|| on the front panel) to start recording.

If you pressed **MONITOR** in step 3, you'll need to press **RECORD ●** here, then **||** or **► (►/||)** to start recording.

6 Restart playback of the source material.

If the **AUTO TRACK** indicator is lit in the display then the recorder will start a new track each time it detects a sound after at least two seconds of continuous silence. (To switch off auto track numbering see **Manually numbering tracks** on page 33.)

7 When you're done, press ■.

After pressing **■**, the display shows **PMA REC** while it records the track information to the disc.

Start method and track numbering in synchro and normal modes

MODE	INPUT	START METHOD	TRACK INC. METHOD	AUTO/MAN
SYNCHRO	CD&MD dig.	Level > -90 dBFS	CD, MD Sub-code	AUTO
SYNCHRO	DAT dig.	DAT START ID	DAT START ID	AUTO
SYNCHRO	ANALOG	Level > A.LVL(MENU)	Level Threshold(A.LVL in MENU)	AUTO
SYNCHRO	CD&MD dig.	Level > -90 dBFS	None	MANUAL
SYNCHRO	DAT dig.	DAT START ID	None	MANUAL
SYNCHRO	ANALOG	Level > A.LVL(MENU)	None	MANUAL
NORMAL	CD&MD dig.	Manual	CD, MD Sub-code	AUTO
NORMAL	DAT dig.	Manual	DAT START ID	AUTO
NORMAL	ANALOG	Manual	Level Threshold(A.LVL in MENU)	AUTO
NORMAL	CD&MD dig.	Manual	None	MANUAL
NORMAL	DAT dig.	Manual	None	MANUAL
NORMAL	ANALOG	Manual	None	MANUAL

Setting the digital recording level

One of the advantages of digital-to-digital recording is that you don't have to set recording levels—and risk distortion by overloading the disc. With pre-recorded material, the digital level has usually been optimized and you shouldn't need to change it. If you're making a digital copy of a CD, DAT or MD that was not optimally produced and that was consistently under-recorded, you can boost the overall level by up to +20dB. Remember though, that any peaks in the original recording run the risk of distorting the copy.

In many other digital recording applications, you may also have cause to boost the recording volume since the volume of some digital sources can be relatively low, but again, if there are any peaks in the source material, you run the risk of momentary distortion.

It's also possible to reduce the digital recording volume, but in most cases, this is not desirable. However, if you're putting together a mix CD (various tracks compiled from different sources), and there is a track which stands out as generally louder than the others, then you might want to reduce the level of that track. Note that this feature will not remove distortion already on the source material.

Once changed, the new digital recording level remains until you change it again, or reset it. Each digital input has its own level which can be set independently.

Note: If you are recording DTS encoded audio CDs or HDCD format CDs, the digital recording level must be set to 0.0dB for recording.

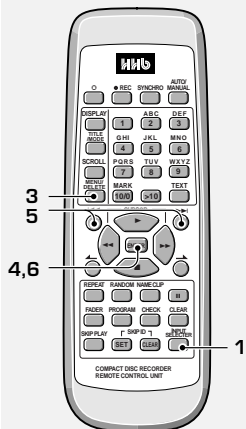
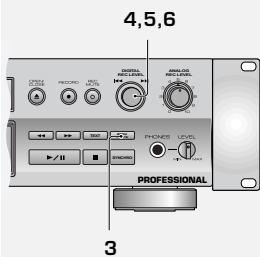
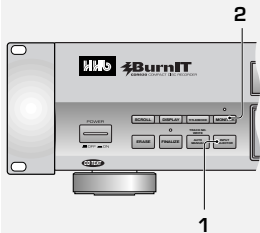

- 1 **Make sure one of the digital inputs is selected.**
Pressing **INPUT SELECTOR** repeatedly switches the active input:

Analog - Optical - Coaxial

The recorder's display indicates the current input.

- 2 **Make sure the recorder is stopped, then press **RECORD** (● REC on the remote control).**

The recorder goes into record-pause. (You can also press **MONITOR**.)

- 3 **Press **MENU/DELETE**.**

- 4 **Turn the jog dial until **D. VOL** appears in the display, then press to **ENTER**.**

If there is nothing connected to the selected digital input, the message **DIN UNLOCK** appears in the display.

The display shows current digital recording level.



- 5 **Turn the jog dial or press **◀◀** or **▶▶** on the remote control to adjust the recording level up or down.**

- The maximum adjustment possible is between **MIN**(silence) and +20dB.
- Pressing the jog dial (**ENTER**) and holding for 3 seconds resets to 0dB.

- 6 **Press the jog dial (**ENTER**) to confirm the digital recording level.**

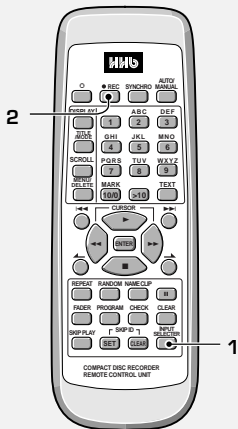
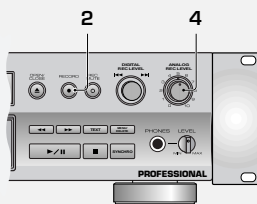
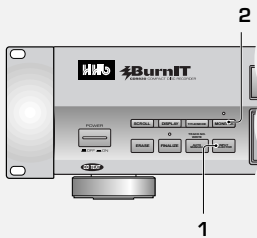

Setting the analog recording level

Compared to analog tape, the distortion that you get from overloading a CD is much less tolerable, and something you'll definitely want to avoid.

What you want to aim for is a level where the loudest sound from your source material is recorded onto the CD at a level just below the point where it overloads (where it produces an unpleasant, buzzy distortion).

1 Press INPUT SELECTOR to choose the analog input.

Pressing INPUT SELECTOR repeatedly switches the active input:

Analog - Optical - Coaxial

The recorder's display indicates the current input.

2 Make sure the recorder is stopped, then press RECORD ● (● REC on the remote control).

The recorder goes into record-pause. (You can also press MONITOR.)

3 Start playing the source.

4 Adjust the recording level using the ANALOG REC LEVEL control.

Don't let the recording level to reach the red OVER indicator!



The maximum recording level should be in this area.

When you're happy with the recording level, stop the source.

Setting the balance

You can increase the relative volume of the right or left channel for both recording and playback. However, it should not be necessary to change the balance of a pre-recorded source.

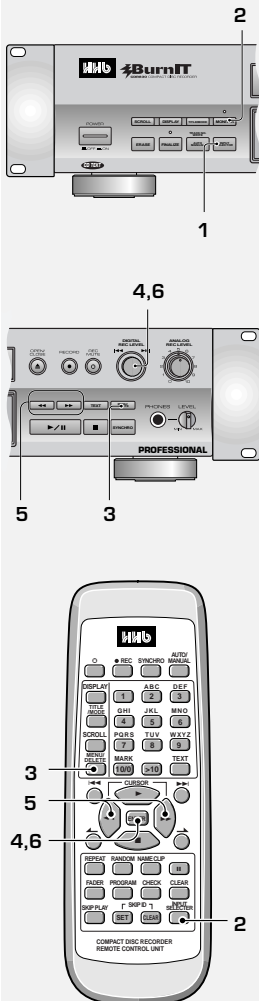

1 Press INPUT SELECTOR to choose an input.

Pressing INPUT SELECTOR repeatedly switches the active input:

Analog - Optical - Coaxial

The recorder's display indicates the current input.

2 Make sure the recorder is stopped, then press RECORD ● (● REC on the remote control).

The recorder goes into record-pause. (You can also press MONITOR.)

3 Press MENU/DELETE.

4 Turn the jog dial until BALANCE appears in the display, then press to ENTER.

5 Adjust the balance using the REC BALANCE buttons (◀ and ▶).

You can adjust the balance from 0dB (default) to around 5dB in either direction for digital recording, and up to around 7dB in either direction for analog recording.

- Pressing the jog dial (ENTER) and holding for 3 seconds resets to center position.

6 Press the jog dial (ENTER) to confirm the balance.

4 Getting started

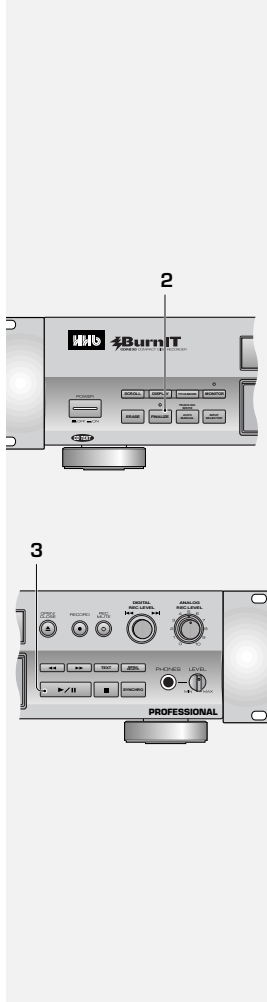

Finalizing a disc

Before you can play a CD-R on an ordinary CD player, the disc must go through a process called finalization. Once finalized, a CD-R disc is no longer recordable, nor will you be able to set or clear skip IDs. Finalization is not reversible for CD-Rs so be absolutely sure that everything on the disc is the way you want it before you start.

CD-RW discs can also be finalized, although you can still erase the disc afterwards and reuse it, so it's not anything like as final as it is with a CD-R disc. A finalized CD-RW disc can only be played on a CD player that is compatible with CD-RW discs (currently only recent players).

Caution!

Finalization takes a couple of minutes. During this time never switch off the power to the unit—the disc may become unusable as a result.

1 Load the CD-R or CD-RW you want to finalize.

Check that the disc is free from dust, dirt and scratches—if necessary, clean the disc, following the guidelines on page 7.

2 Press FINALIZE.

The **FINALIZE** indicator lights. After a short while you should see a display something like this:

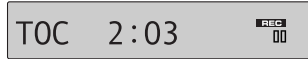

The display shows how long finalization will take—the exact time taken depends on the disc.

Press ■ here to cancel finalization.

3 Press II (▶/II) on the front panel) to start finalization.

Finalization takes about two minutes; you'll see how long there is remaining in the display. The player stops when finished.

For a CD-R, the CD-R indicator now changes to simply CD.

For a CD-RW, the finalize indicator lights in the display.

None of the controls on the player or the remote have any effect during finalization. If, however, the recorder hasn't managed to finalize the disc within 10 minutes, you can abort the operation by pressing ■. If you do this, the disc won't be playable on an ordinary CD player.

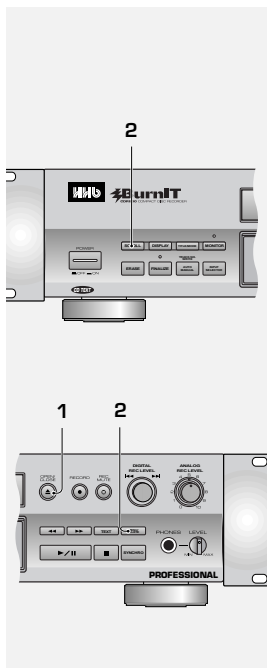

Resetting the recorder

This erases all saved text information and returns the recorder to its factory settings:

- Copy-bit setting - PERMIT
- Fade length - 5 SEC
- Time increment recording - OFF
- Silence threshold level - -54 dB
- Digital volume - 0.0 dB
- Balance - CENTER

1 Eject the disc if there is one in the recorder.

2 Hold down **SCROLL** then press **MENU/DELETE**.

Note: If you have finished all the recording you would like to do, and have set CD text for a disc, make sure to finalize the CD before resetting.

Programming the track order

Programming the track order means telling the player precisely which tracks, and in what order, you want played. You can program a playlist of up to 24 tracks, playing tracks more than once if you like.

The playlist you program applies only to the disc in the player at the time: as soon as you eject that disc the playlist is lost.

- 1 **Make sure the player is stopped, then press PROGRAM.**

The PGM indicator lights and the display prompts you to enter the first track in the program:



As you program tracks, the total running time of the program is displayed here.

- 2 **Enter the track numbers in the order you want them played.**

There are three ways to enter track numbers:

- **Using the number buttons**
For track numbers 1 to 10, use the corresponding number button.

For track numbers over 10, press the >10 button, then enter the track number. For example, to select track 28:



- **Using the track skip buttons**
Use the ◀◀ and ▶▶ buttons to select a track; press PROGRAM to enter it into the playlist.
- **Using the jog dial**
Turn the jog dial to select a track; push to enter it into the playlist.

- 3 **Press ▶ (▶/|| on the front panel) to start playback.**

You must press PROGRAM if you want to enter another track after you have started playback.

Clearing the playlist

Since the program only applies as long as the disc is in the player, you can clear it by simply ejecting the disc. Alternatively, press ■ while the disc is stopped.

Clearing a track from the playlist

Delete the last (most recently) programmed step by pressing CLEAR. Press repeatedly to clear several steps (if the program is playing while you're doing this, you can't clear steps beyond the one that is currently playing).

Checking what's in the playlist

While the disc is stopped, you can check the contents of the playlist using CHECK on the remote control. Each press steps through the playlist, showing the step number and the corresponding track number.



Programmed step number Programmed track number

Replacing a track in the playlist

While checking the playlist (see above), you can change the track number for the step you're on using either the number keys, the ◀◀ and ▶▶ buttons, or the jog dial.

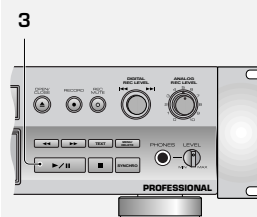
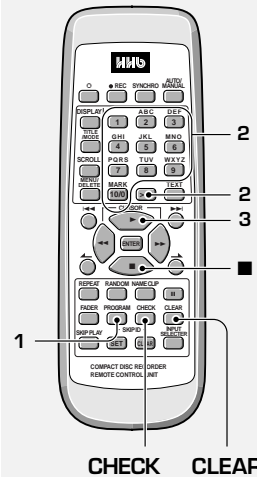
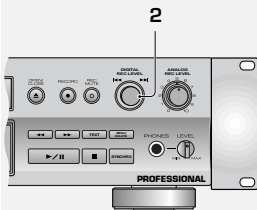

5 More playback features



REPEAT

RANDOM

Playing tracks at random

Selecting random play leaves the track order of the disc up to the player. Each track on the disc is played just once, but in a random order.

Press RANDOM during playback or when the disc is stopped.

The RDM indicator lights up in the display and random playback starts.

- Pressing ■ cancels random play.

Repeating tracks

Using the repeat play function you can repeat either the current track over and over, or the entire disc.

- **To repeat the current track, press REPEAT once.**

The RPT-1 indicator lights up in the display and the current track repeats until you either press ■, or press REPEAT twice. Either way, repeat is canceled.

You can use repeat track in normal, program or random play modes.

- **To repeat the whole disc, press REPEAT twice.**

The RPT indicator lights up in the display and the CD repeats until you press either ■ or REPEAT again (in which case the disc continues playing to the end, then stops).

You can use repeat disc in normal, random or program play modes.



FADER

SKIP PLAY

Fading in and fading out

Use the fader feature to fade the volume down gradually and pause playback, or to have the player fade in the volume when you resume playback. You can also set the length of time over which you want to fade in or fade out (See *Setting the fade length* on page 34).

Note: You can only hear the fades through the analog outputs.

- 1 **Press FADER during playback to pause the disc.**

The fader indicator in the display blinks and the volume fades to zero. The player then pauses playback.

- 2 **Press FADER to resume playback of a paused disc.**

The fader indicator in the display blinks and the volume starts to fade in.

Playing a disc with skip IDs

If you're not sure whether a disc has skip IDs programmed, look for the SKIP ON indicator in the display when you load a disc—it will light automatically if one or more are present.

- 1 **Load a disc.**
The SKIP ON indicator lights up if there are any skip IDs on the disc. This means the player won't play those tracks that are marked by skip IDs.

- 2 **Press SKIP PLAY to switch skip play on/off, then press ► (▶/|| on the front panel).**

When you turn off skip play, the player ignores the skip IDs and plays all tracks on the disc.

- If there were no skip IDs on the disc in the first place, the SKIP PLAY button has no effect.

01 01 00:00 (SKIP ON)

The SKIP ON indicator lights if there are skip IDs present on the disc.

5 More playback features

Skipping unwanted tracks

Although you can't erase tracks on a CD-R disc, you can set what are called 'skip IDs'. These tell a CD player (though not all recognize skip IDs) not to play a particular track, and to skip to the next one on the disc.

You can also set skip IDs on CD-RWs, although it's probably a less useful feature since erasing the last track is possible should you make a mistake in recording.

If you make a mistake when setting a skip ID, you can clear it, but be careful: you can set up to 21 skip IDs per disc, but repeatedly setting and clearing skip IDs will reduce this number.

Setting skip IDs

- 1 Press **SKIP ID SET** during playback (or paused playback) of the track you want to skip.

If there's no room left on the disc to record another skip ID, the display will show the message **FULL**.

- 2 The display prompts you to confirm.

Press **SKIP ID SET** again to confirm. To cancel, press either **SKIP ID CLEAR** or **▶ (▶/||)**.

- Use the **◀◀** and **▶▶** buttons/jog dial to skip to other tracks that don't have skip IDs set. When you press **SKIP ID SET**, it will be for the track that is currently playing.
- If there's no room left on the disc to record a skip ID, the display will show the message **SKIP FULL**.

- 3 Set further skip IDs by repeating steps 1 and 2.

- 4 When you're finished, stop the disc and press **OPEN/CLOSE ▲**.

Until you eject the disc, the recorder stores the skip ID information in its memory. On pressing **▲**, the recorder writes the skip ID information onto the disc.

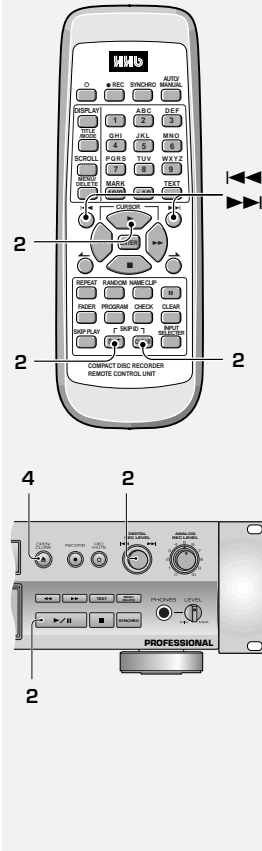

Clearing skip IDs

- 1 Press **SKIP PLAY** to switch off skip play mode. The **SKIP ON** indicator in the display disappears.

- If the **SKIP ON** indicator did not light up when you loaded the disc then there are no skip IDs present on that disc.

- 2 Press **SKIP ID CLEAR** during playback (or paused playback) of the track you no longer need a skip ID for.

If this track doesn't have a skip ID, the player jumps to the next track that does and starts playback of that track.

- 3 The display prompts you to confirm.

Press **SKIP ID CLEAR** again to confirm. To cancel, press either **SKIP ID SET** or **▶ (▶/||)**.

- Use the **◀◀** and **▶▶** buttons/jog dial to move between tracks that have skip IDs set. When you press **SKIP ID CLEAR**, it will be for the track that is currently playing.
- If there's no room left on the disc to clear a skip ID, the display will show the message **SKIP FULL**.

- 4 Clear further skip IDs by repeating steps 2 and 3.

- 5 When you're finished, stop the disc and press **▲**.

Until you eject the disc, the recorder stores the changes in skip ID information in its memory. On pressing **▲**, the recorder writes the new skip ID information onto the disc.

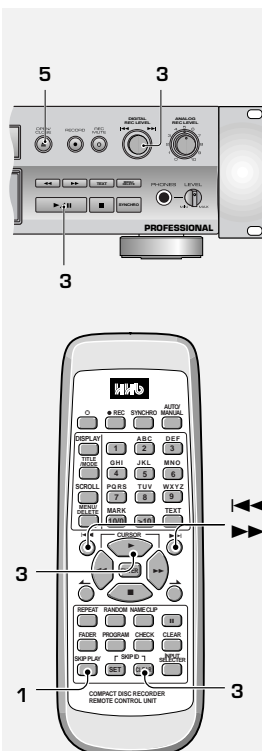

6 More recording features

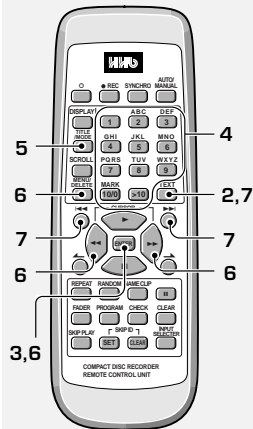
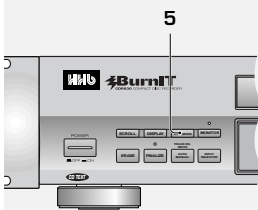
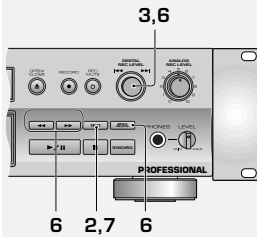

0!"#\$%&'()*+,-./<=> ?
@[] ^ _ '{ } <space>

Using CD text

You can name a CD-R or CD-RW so that when you load the disc into the player, the disc name, track title, or artist name can appear in the display. Each title can be up to 120 characters long, including spaces. You can store all the text (up to 2000 characters) for up to three non-finalized discs in the recorder at one time. This is useful when you want to edit the text during another recording session with the same disc.

Be careful: When you set text for a fourth disc, the oldest text information (for the first disc) is deleted from memory. Text with CD-RW discs is deleted when you erase the corresponding track.

Once you finalize a CD-R, the text information cannot be changed. Finalized CD-Rs containing CD text can still be played on ordinary (non-CD text compatible) CD players, however the CD text will not appear in the display.

1 Make sure the disc you want to name is loaded into the recorder and is stopped.

For track names: Before proceeding to step 2, you must choose the track you want to name by turning the jog dial. You can also name tracks during playback.

2 Press TEXT.

Press **TEXT** to switch between disc and artist name:

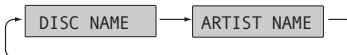

If you are naming a track, go to step 3.

The default is disc title. Press ■ at any time to exit.

3 Wait two seconds after making your selection, or press ENTER.

If the disc doesn't already have a name, the character display is blank, with a blinking cursor on the first character.

If the disc is already named, the character display shows the name (or the first 12 characters if it is too long to be displayed completely), with a blinking cursor under the first character.

4 Select/change the character at the current cursor position by turning the jog dial.

See below for the complete list of letters, numbers, and symbols available.

If you're using the remote control, use numbers keys 1-9 for numbers and the letters shown above each key. Press a key repeatedly to cycle through the letters and numbers on that key.

Characters available for disc and track names:

ABCDEFGHIJKLMNOPQRSTUVWXYZ

abcdefghijklmnopqrstuvwxyz

1234567890

!"#\$%&'()*+,-./<=> ?

@ [] ^ _ '{ } <space>

5 Change between uppercase, lowercase, and numbers/symbols by pressing TITLE/MODE.

The case of the character at the current cursor position changes between upper- and lowercase and numbers/symbols with each press.

6 Confirm the character and move the cursor to the next character position by pressing the jog dial (or ►►).

For the remote, move the cursor to the next character position by pressing **ENTER**.

- Move the cursor backwards or forwards along the display using ◀◀ and ▶▶.
- Insert a new character into a name by moving the cursor to the character position you want and repeating steps 4–6.

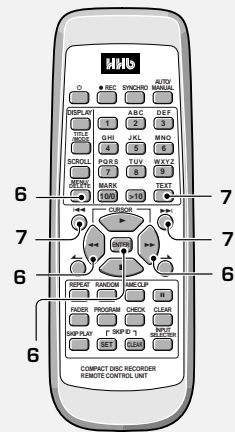
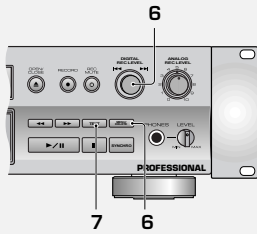

- Erase the character at the current cursor position by pressing **MENU/DELETE**.

The characters on either side of the current cursor position close to fill up the gap.

7 Press **TEXT** again to enter the text and return to the title selection display.

If you are inputting a track title, you must assign it to a track number using **I◀◀** or **▶▶I**, or the corresponding number on the remote control. Pressing **TEXT** twice takes you back to the previous menu (step 2).

Note: After you have finished setting the names you want in CD text, be sure to eject the disc or, if you have finished all the recording and editing that you want to do, finalize the disc as shown on page 26.

Editing CD text

The CD recorder can store information for up to three discs at one time. When an unfinalized CD-R containing CD text is loaded, this text will automatically return to memory. Before finalizing the CD-R, you can go back and edit the text as many times as you like, or until you input CD text for a fourth disc (this will erase the oldest information in memory).

1 Load the CD-R or CD-RW you wish to edit.

2 Press **TEXT**.

Choose the name you wish to edit as in steps 1–3 of *Using CD text*.

3 Edit the text.

See step 6 of *Using CD text*.

4 Eject or finalize the disc.

See *Finalizing a disc* on page 26 if you have finished all the recording and editing that you want to do.

6 More recording features

Copying track names to other tracks

If you need to name several tracks with similar names—several parts of one suite, for example—you can name the first one using the procedure detailed above, then simply copy that name to the other tracks and edit them as required. This can save you a lot of time over naming each track individually. The recorder stores the last three names you've copied using the name clip function in its memory (up to 40 characters each). When you copy another track name, the oldest one is deleted from memory.

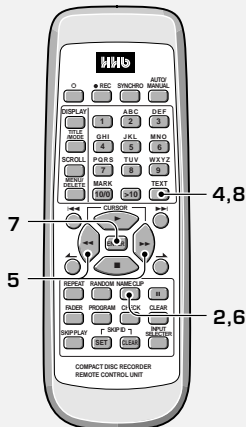

- 1 **Go to the track with the name you want to copy.**
Use one of the usual methods—track skip, direct selection, etc.
- 2 **Press NAME CLIP to copy the currently displayed track name into memory.**
The display should confirm that the track name has been copied and the display flashes **name clip** briefly.
- 3 **Go to the track that you want to copy the name to.**
- 4 **Press TEXT to start editing the current track name.**
- 5 **Move the cursor to the position you want to insert the copied name.**
Use the ◀ and ▶ buttons to move the cursor around the character display.

- 6 **Press NAME CLIP again.**
The most recently clipped name appears.
- 7 **Use the jog dial to select one of the previous three names stored, then press the jog dial (ENTER).**
On the remote, use the ◀ and ▶ buttons to select a name, then press **ENTER**.
The display flashes **Name Insert** briefly and the selected name is inserted at the point you chose.
 - Edit the name further if necessary.
- 8 **Press TEXT to leave the track name mode.**

6 More recording features

Automatically numbering tracks

If you're recording from CD, MD, DCC or DAT, you can usually let the recorder number the tracks automatically as they change on the source material. When recording other digital or analog sources, the recorder will start a new track if it detects more than 2 seconds of silence. However if you're recording noisy source material or a classical recording with long quiet sections, the recorder may not always recognize the gap between tracks. For this reason you can adjust the level of sound that the recorder regards as 'silence'.

Each input (analog, coaxial and optical) has its own threshold level, which can be set independently.

Note: The minimum analog threshold level is **-66dB**.

- 1 When the recorder is stopped, press **MENU/DELETE**.

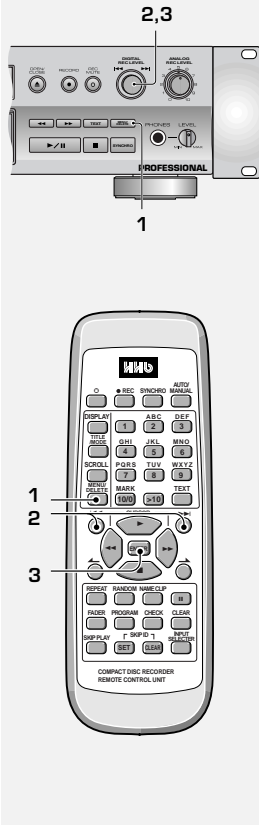

- 2 Turn the jog dial until **A.LVL** appears in the display, then press to **ENTER**.

The display shows the current 'silence' threshold for automatic track numbering. The default is **-54dB**.

- 3 Turn the jog dial (**◀◀** and **▶▶** on the remote) to change the threshold level. Turning the dial cycles through the following levels:

-78dB to -66dB – Use these levels if you find the recorder is putting in new track numbers during very quiet sections of classical music, for example.

-60dB to -48dB – A 'mid' level suitable for most recordings.

-42dB to -24dB – If you find that the recorder is not putting in new track numbers because the original source is too noisy.

- 4 Press the jog dial (**ENTER**) to confirm the new level.

If the **AUTO TRK** indicator is not lit, press **AUTO/MANUAL** to switch it on. To check that tracks will start at the correct points on the recording, see *Monitoring a source* on page 36.

Manually numbering tracks

Although automatic track numbering is the default mode of the recorder, you can number tracks manually as recording is taking place. In some cases—such as recording from digital mixer, or from an analog source—auto track numbering may not work reliably (in these cases, a new track is started after the recorder detects two seconds of silence), and it's better to use manual track numbering.

Remember: It is not possible to edit track numbers after recording.

- 1 Make sure automatic track numbering is switched **OFF**.

If the **AUTO TRK** indicator is lit, press **AUTO/MANUAL** to switch it off.

- 2 Start recording.

You can use manual numbering in any record mode, but it is best suited to manual digital-input or analog-input recording (see page 18 for more on these recording modes).

- 3 Press **RECORD** ● at any point you want a new track to start.

CD tracks must be at least four seconds long—the recorder won't let you start a new track less than four seconds into the current track.

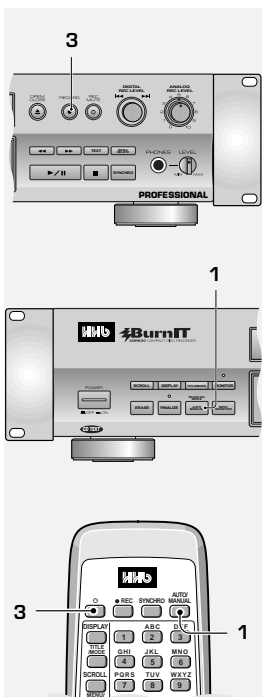

6 More recording features

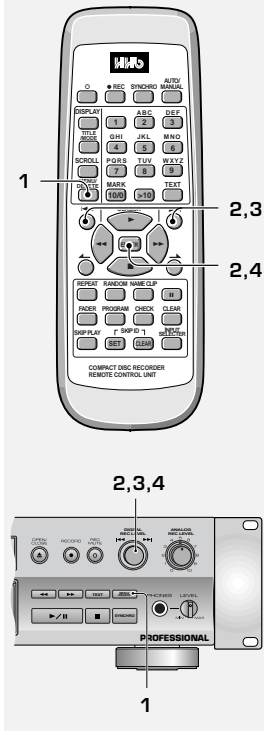

Starting tracks in time increments

If you aren't able to set track numbers automatically during recording (a long interview, for example), you might want to have the recorder start tracks after every three minutes or so. This will make it easier to listen back to sections of the recording at a later date. You can set the time to one, three, or five minutes.

Note: The time increment will default to **OFF** when: recording is stopped; auto track numbering is turned off; power is turned off.

- 1 When the recorder is stopped, press **MENU/DELETE**.
- 2 Turn the jog dial (**◀◀** and **▶▶** on the remote) until **T. INC.** appears in the display, then press to **ENTER**.
The display shows the current time increment: one, three, five minutes, or **OFF**. The default is **OFF**.
- 3 Turn the jog dial (**◀◀** and **▶▶** on the remote) to change the time increment.
- 4 Press the jog dial to **ENTER**.

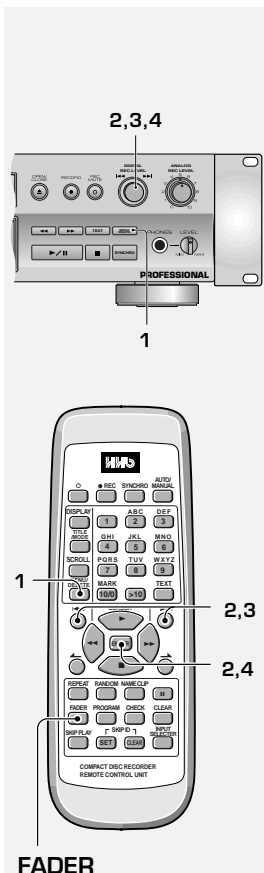

Recording fade ins and fade outs

Sometimes, for example if you're recording just an excerpt from something, it may be better to fade in the recording, then fade out again at the end, rather than start and end abruptly. You can also set longer or shorter fade times so that they match the fades on other songs in your mix. Note that you can't record a fade in when in synchro recording mode (although you can record a fade out).

Setting the fade length

- 1 Press **MENU/DELETE**.
- 2 Turn the jog dial until **FADER** appears in the display, then press to **ENTER**.
- 3 Use the jog dial (**◀◀** and **▶▶** on the remote) to set the length of the fade (in seconds).

Each turn will take you forward (or back) one second. The default is 5 seconds.

- 4 Press the jog dial (**ENTER**) to confirm the new fade length.

Recording a fade in

- With the source playing, press **FADER** during record-pause mode to fade in. Recording starts with a gradual fade in.

Recording a fade out

- Press **FADER** during recording to fade out. After recording the fade out, the recorder goes into record-pause mode. This happens in either normal or synchro record mode.
 - You can also just press **■** if you don't need a fade out.

If you record a fade out during all-track sync mode, the synchro mode is canceled after the fade out (see pages 19–21 for more on synchro recording).

6 More recording features

Recording blank sections

This feature is useful wherever you need some blank space recorded on the disc, for instance, at the end of a recording session so that the next track doesn't follow the last too closely. Note that you can't start a recording with a muted recording; only after a recording has started, or at the end of a recording.

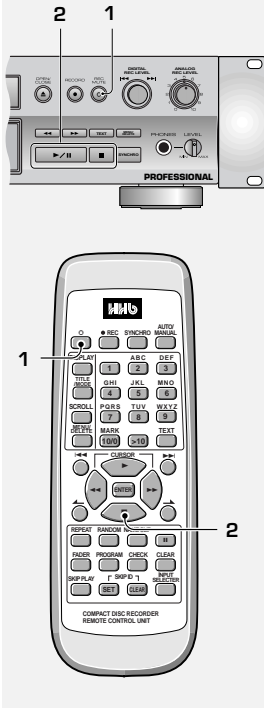

- 1 While recording or during record-pause mode, press **○ REC MUTE**.

A blank space of about four seconds is recorded, then the recorder goes into record-pause mode.

- If you press and hold **○ REC MUTE**, you can record a blank for as long as you hold down the button.
- Pressing **○ REC MUTE**, (without holding) in record-pause mode records four seconds of silence from the current position. Use this to create a space between tracks when recording in 1-track synchro mode, for example.

- 2 Press **■** to finish the recording session.

Checking what's at the end of a disc

You don't have to record a whole disc at once. Until you finalize the disc, further recording is possible from the end of the last track you recorded (assuming there are fewer than 99 tracks already on the disc). Here's how to check what's on the last recorded section of the disc before recording new material:

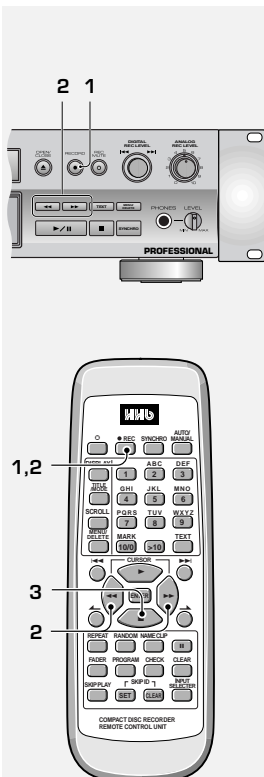

- 1 Press **● RECORD**.

The recorder goes into record-pause mode.

- 2 Press and hold **◀◀**.

You'll hear the last recorded track in reverse. Release the button and the track plays normally to the end.

While the track is playing you can use the **◀◀** and **▶▶**.

If you press **● RECORD** again while the track's playing, the recorder jumps to the end of the track and goes into record-pause.

When the track has finished playing, the recorder automatically enters record-pause again.

- 3 Once the player is back in record-pause mode you can go ahead and record normally.

If you decide you don't want to record, just press **■**.

6 More recording features

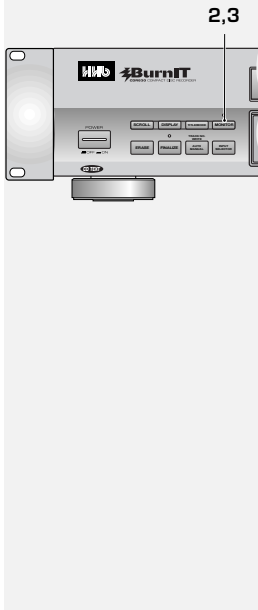

Monitoring a source

When recording, or in record-pause mode, the source signal is always available for monitoring through a connected audio system or through a pair of headphones plugged into the CDR-830's phones jack. Even if you're not recording, you can still monitor—useful for cueing up for the next recording and also for checking that tracks are starting in the proper places during automatic track numbering.

- 1 Start the source component playing.**
Make sure that the input selector is set to the correct input.

- 2 Press MONITOR.**
The indicator above the **MONITOR** button lights up.
 - When automatic track numbering has been selected, the **TRACK** indicator will light for 2 seconds at track start points. See *Automatically numbering tracks* on page 33 if you find the recorder can't recognize the gaps between tracks.
 - When monitoring through a digital output, you cannot hear changes you make in the recording level or balance.
- 3 To switch off monitoring, press MONITOR again.**
The monitor indicator switches off.

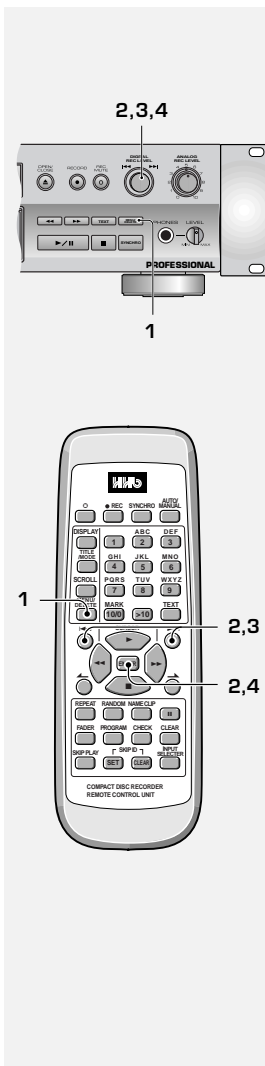

To establish the copy-bit (SCMS) setting

These settings control the number of generations of digital copies that can be made from the recorded disc. Use this function to set whether the disc can be copied unlimited times, once, or not at all. The status of the copy-bit in the incoming digital signal is ignored and the copy-bit setting on the recorded disc is only set by this menu function.

- 1 Press MENU/DELETE.**
- 2 Turn the jog dial until COPY : PERMIT appears in the display, then press to ENTER.**
- 3 Use the jog dial (◀◀ and ▶▶ on the remote) to select the copy flag setting.**
The default setting is copy permit. Turn the dial to cycle through the following settings:
 - COPY : PERMIT**
– Permits unlimited copies
 - COPY : ONCE**
– Permits one copy only
 - COPY : INHIBIT**
– Restricts all copying
 - When the original setting is changed, a question mark (?) blinks next to the selected option.
- 4 Press the jog dial (ENTER) to confirm the setting.**
The question mark disappears from the display and the new setting is confirmed.

Erasing a CD-RW disc

Although more expensive than CD-R discs, the great advantage of CD-RW is that the discs can be erased and reused. Various erase options are available depending on whether the disc has been finalized.

A third, special option, erases (re-initializes) the whole disc. This process takes quite a long time to complete and should be used for recovering damaged discs, not for erasing tracks from a healthy disc.

Caution!

Never switch off the power during CD-RW erasing - your disc may become unusable.

If the message **CHECK DISC** appears any time during any erase process, press **▲**, take out the disc, clean it, then try the erase command again.

Be sure to remove the disc from the recorder before switching off the power, otherwise the erase operation will not be completed.

When a non-finalized disc is loaded

1 Press ERASE.

The display shows **ERASE LAST?**.

- Press **■** to cancel last track erase here.

2 Use the jog dial or press **◀◀** and **▶▶** on the remote control to change the erase option.

Switch between:

ERASE LAST? – erase just the last track

ERASE ALL? – erase all tracks

ERASE 02-[LAST TRACK]? – erase track 2 and all subsequent tracks

ERASE 03-[LAST TRACK]? – erase track 3 and all subsequent tracks

Keep turning the jog dial or press **◀◀** and **▶▶** on the remote control to change the number of tracks to erase.

3 Press **||** (**▶/||** on the front panel) to start erasing.

The process takes just a few seconds. During this time, the function indicator lights.

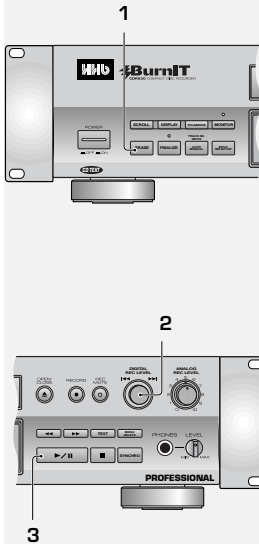

6 More recording features

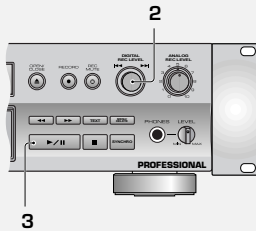
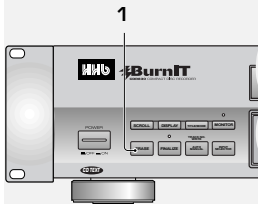

3

When a finalized disc is loaded

Be careful: When you erase the TOC, the CD text information for the disc is also copied to memory for editing purposes, erasing the oldest text information stored (as explained on page 30).

- 1 Press ERASE.**
The display shows **ERASE TOC?**.
Press ■ to cancel erase here.
- 2 Use the jog dial or ◀◀ and ▶▶ buttons on the remote control to change the erase option.**
Switch between:
ERASE TOC? – erase the table of contents (returns disc to a non-finalized state)
ERASE ALL? – erase all tracks
- 3 Press || (▶/|| on the front panel) to start erasing.**

The function indicator lights and the display shows **ERASE**, and the time remaining to completion.

You can halt this erase process by holding down the ■ button for 10 seconds.

Reinitializing a disc

- 1 Press and hold ERASE for about four seconds.**
The recorder prompts you to confirm with the message **INITIALIZE?**.
Press ■ to cancel all disc erase here.
- 2 Press || (▶/|| on the front panel) to start erasing.**
The process takes about 40 minutes, depending on the disc. During this time, the display shows **ERASE**, followed by the remaining time to completion.
You can halt this erase process by holding down the ■ button for 10 seconds.

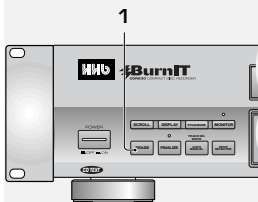

Understanding display messages

Below is a list of messages you'll see during normal operation of the CDR-830 together with a brief explanation of what they mean.

If you need more information, turn to the page indicated.

Note: In the table below, ** indicates a track number.

Message	Description	Reference
TOC READ	The recorder is reading the disc's TOC (Table of Contents). Wait for the message to disappear.	p. 15
SYNC-1	The unit is in 1-track automatic digital recording mode. Recording starts when the recorder detects the digital source input signal.	p. 19
SYNC-ALL	The unit is in all-track automatic digital recording mode. Recording starts when the recorder detects the digital source input signal.	p. 20
PMA REC	The recorder is writing TOC data to the disc's PMA (Program Memory Area). Never turn off the power while this display is showing.	
** SKIP SET	Confirm that you want to set a skip ID by pressing the SKIP ID SET button.	p. 29
** SKIP CLR	Confirm that you want to set a skip ID by pressing the SKIP ID CLEAR button.	p. 29
ERASE LAST?	Confirm that you want to erase the last track of a CD-RW disc by pressing ►/ (on the remote control).	p. 37
ERASE ALL?	Confirm that you want to erase all tracks on a CD-RW disc by pressing ►/ (on the remote control).	p. 37
ERASE TOC?	Confirm that you want to erase the TOC of a finalized CD-RW disc to return it to a non-finalized state. After doing this, you can record more material on the disc.	p. 38
ERASE ** - ** ?	Confirm that you want to erase tracks recorded on a CD-RW disc.	p. 37
INITIALIZE?	Confirm that you want to re-initialize the CD-RW disc by pressing ►/ (on the remote control).	p. 38

7 Additional information

Troubleshooting

Below is a list of messages mainly related to playback and recording problems, together with a brief explanation and a page reference where you can find more information:

Display	Cause	Remedy
CHECK DISC	The disc is damaged or dirty.	Take out the disc and check for dust, dirt, scratches, etc. Clean as necessary.
	The disc is loaded upside down.	Take out the disc and reload it label-side up. If the same message is displayed again after the disc is reloaded, turn the CDR-830 power switch off, and after a few seconds on again. If the same message is still displayed, please contact a HHB authorized service center.
CHECK (blinking display)	A system error occurred, perhaps due to noise or static electricity.	Turn the CDR-830 power switch off, and after a few seconds on again. If the same message is displayed again, please contact a HHB authorized service center.

Display messages relating to playback

Display	Cause	Remedy
NEW DISC	A blank disc is loaded.	Only recording is possible on blank CD-R or CD-RW discs. Playback is not possible.
NO DISC	An attempt is made to start playback without loading a disc.	Open the tray and check that a disc is loaded.

Display messages relating to recording

Note: In the table below, ** indicates a track number.

Display	Cause	Remedy
Can't SYNC	This appears when the SYNCHRO button is pressed when the input selector is set to a digital input, and the source selected is not recognized as CD, MD, DCC, or DAT.	Record the source manually, or record through the analog input.
DIN UNLOCK	The digital source was interrupted. The source is not audio, or is an incompatible format (e.g. a CD-ROM).	Check that the digital input cable is connected properly and that the power of the source player is on. Check that the source is a regular music source.
CHECK INPUT?	The source player was already playing when the SYNCHRO button was pressed.	Stop the source player. After a short time, SYNC-1 or SYNC-ALL is displayed, and the recorder goes into synchro-record-pause mode.
** SET UP	The unit is preparing to record.	Wait until the message disappears.
REPAIR	The recorder was switched off/unplugged after recording without ejecting the disc. The recorder could not write essential recording information onto the disc.	While REPAIR is displayed, the recorder automatically examines the recorded area of the disc and updates the track numbers and recording time data. This process takes about 40 minutes for a fully recorded disc. Finalization or further recording is possible once the REPAIR message disappears.
REC FULL	No more recording is possible because the available recording time of the disc has been used up, or 99 tracks have already been recorded on the disc.	Use another disc, or erase the CD-RW disc.

If digital synchro-recording fails to operate correctly, check the following:

1. Pause playback of the source, then press the DIGITAL SYNCHRO button again.
 - If you're recording from a portable CD player, etc., make sure that the shock-protection feature is switched off.
2. Start playback of the source component once you see the SYNCHRO indicator start to blink.
3. If none of the above solves the problem, use manual digital recording to record.
 - Digital synchro-recording uses a digital sub-signal contained in the source player's digital output. Digital synchro-recording will not work when recording from the following devices:
 - CD players whose digital output does not include a sub-signal
 - Portable CD, MD or DVD players which do not output a digital signal when stopped.

7 Additional information

It's often easy to mistake incorrect operation for trouble and malfunction of the unit. If you think there is something wrong with the component, check the points below first. If the problem persists, contact your nearest HHB authorized service center and have them check over the unit.

Symptom	Cause	Remedy
Power cannot be turned on.	The power cord is unplugged from the wall outlet.	Plug the power cord into a power outlet.
	The power plug is not firmly connected to the recorder.	Make sure that the power plug is fully inserted in the recorder.
No sound is heard during playback.	The recorder is not connected up properly.	Check all connections, especially to the amplifier (p.10–11).
Cannot record.	The recorder is not connected up properly. The CD-R or CD-RW disc in use has already been finalized. The input selection is incorrect.	Check all connections (p.10–11) Use a non-finalized disc or erase the CD-RW disc (p.38). Select the input for the correct input source to the recorder.
	The REC LEVEL control is set too low.	Increase the recording level (p.23–24).
Recorded sound is distorted.	The REC LEVEL control is set too high.	Reduce the recording level (p.23–24).
	Signal connections are incorrect. There is interference from external sources.	Check all connections (p.10–11) Turn the power off to other units near the recorder until there is no interference.
	The disc is damaged or warped. The disc is extremely dirty.	Use another disc. Clean the disc.
Remote control operation is impossible.	The remote control batteries are exhausted.	Replace both of the remote control batteries with new ones.
	There is an obstacle between the remote control unit and main unit.	Remove the obstacle.
	The remote control unit is being operated outside the remote controllable range.	Operate in the remote controllable range (p.9).
Some tracks are skipped without being played.	The SKIP PLAY button is set to on.	Set the SKIP PLAY button to off (p.28).
Skip playback does not occur.	The SKIP PLAY button is set to off.	Set the SKIP PLAY button to on (p.28).
The recorder does not recognize the end of tracks during sync recording.	The level that the recorder regards as 'silence' is set either too low, or too high.	Set the silence threshold to a suitable level for automatically numbering tracks (p.33).
A recorded CD-R disc cannot be played on other CD players.	The disc has not been finalized after recording. When such a disc is loaded, the CD-R indicator lights up.	Finalize the disc (p.26).
	The pickup lens of the other CD player is dirty, impairing its ability to play CD-R discs.	Try the disc on a different CD player. If it plays OK then get the pickup lens on the original player cleaned.

Specifications

1 GENERAL

Model Compact disc audio system
 Applicable discs CD (playback), CD-R and CD-RW
 Power supply
 AC 120 V, 60 Hz (U.S. and Canadian models)
 AC 220-240 V, 50/60 Hz (European model)
 Power consumption
 13 W (U.S. and Canadian models)
 14 W (European model)
 Operating temperature
 +5 °C to +35 °C (+41 °F to +95 °F)
 Weight (without package) 3.9 kg (8 lb 10 oz)
 Max. dimensions
 482.6 (W) × 295 (D) × 105 (H) mm
 19 (W) × 11 5/8 (D) × 4 1/8 (H) in
 Height excluding feet 89 mm / 3 1/2 in

2 AUDIO

Frequency characteristics
 10 Hz to 20 kHz ± 0.5 dB
 RCA phono output level (0 dBFS, 10 kΩ load)
 9 dBu
 Wow & flutter unmeasurable

Playback

Signal to noise ratio > 108 dB
 Dynamic range > 98 dB
 Total Harmonic Distortion @ 1 kHz < 0.0023 %
 Channel Separation > 98 dB

Recording (analog input)

Signal to noise ratio > 92 dB
 Dynamic range > 92 dB
 Total Harmonic Distortion @ 1 kHz < 0.003 %

Recording (digital input, fs=44.1 kHz)

Signal to noise ratio > 108 dB
 Dynamic range > 97 dB
 Total Harmonic Distortion @ 1 kHz < 0.0023 %
 All audio measurements are to EIAJ standards.

3 I/O CONNECTIONS

Analog connectors

Line input - unbalanced
 RCA Phono (input impedance 10 kΩ)
 Line output - unbalanced RCA Phono
 Headphone output 1/4" stereo jack

Digital connectors

Coaxial digital input (SPDIF) RCA Phono 75 Ω
 Coaxial digital output (SPDIF) RCA Phono 75 Ω
 Optical digital input (SPDIF) TOSlink
 Optical digital output (SPDIF) TOSlink
 Optical wavelength 660 nm ± 30 nm

4 ACCESSORIES

- Remote control unit 1
- Size AA/R6P dry cell batteries 2
- Audio connection cord - RCA phono 2
- AC power cord 1
- HHB CDR 80 Silver disc 1
- Operating Instructions 1
- Registration card 1
- HHB CDR830 BurnIT brochure 1
- BurnIT quick reference guide 1

NOTE : *The specifications and design of this product are subject to change without notice, due to improvements.*

Published by HHB COMMUNICATIONS LTD.
 Copyright © 2000 HHB COMMUNICATIONS LTD.
 All rights reserved.



HHB Communications Ltd 73-75 Scrubs Lane, London NW10 6QU, UK. Tel: 020 8962 5000 Fax: 020 8962 5050 E-Mail: sales@hnb.co.uk
HHB Communications USA LLC 1410 Centinela Avenue, Los Angeles, CA 90025-2501, USA. Tel: 310 319 1111 Fax: 310 319 1311 E-Mail: sales@hhbusa.com
HHB Communications Canada Ltd 260 King Street East, Toronto, Ontario M5A 4L5, Canada. Tel: 416 867 9000 Fax: 416 867 1080 E-Mail: sales@hhbcanada.com

Visit HHB on-line at: <http://www.hhb.co.uk>

HOW TO WRITE CD TEXT

1. Insert a recordable disc
2. Press TEXT to select DISC NAME or ARTIST NAME. After about 2 seconds, a flashing cursor will appear at the left hand side of the display.
3. Rotate the DIGITAL RECORD LEVEL (◀ ▶) control to find a character; then press the same control to select and move the cursor one space to the right. Repeat this procedure until finished, then press TEXT to store the information.
Note: it is possible to use the TITLE/MODE button as a shortcut for accessing lower case, upper case and digit/symbol characters.
4. Confirm that the TEXT has been stored by pressing the TITLE/MODE button.
5. To write a TRACK NAME, select the relevant track using ◀ ▶, then press TEXT. After about 2 seconds, a flashing cursor will appear at the left hand side of the display.
6. Rotate the DIGITAL RECORD LEVEL (◀ ▶) control to find a character; then press the same control to select and move the cursor one space to the right. Repeat this procedure until finished, then press TEXT to store the information.
7. Confirm that the TEXT has been stored by selecting the track and then pressing the TITLE/MODE button.
8. CD Text can also be entered from the remote control (see page 30 of the operations manual).

HOW TO MAKE A DISC PLAYABLE IN A STANDARD CD PLAYER - FINALIZE

1. Insert the recorded CD-R or CD-RW which you want to finalize. Note: many CD players are unable to read CD-RW type discs even when finalized.
2. Press FINALIZE and then wait for the display to show approximately 2 minutes on the counter.
3. Press PLAY to start finalization. This process takes approximately 2 minutes. Do not disturb the CDRB30 during finalization. You may notice the count down pause temporarily during finalize - this is normal.

MENU FUNCTIONS

- COPY [PERMIT; ONCE; INHIBT]
- FADER [1 to 12 seconds]
- T.INC [OFF; 1min; 3min; 5min]
- A.LVL [-78 to -24dB]
- D.VOL [-84 to +20dB]
- BALANCE [L>C>R; 29 steps]



FIRST WE LISTEN

www.hhb.co.uk

HHB Communications Ltd · 73-75 Scrubs Lane, London NW10 6QU, UK
Tel: 020 8962 5000 · Fax: 020 8962 5050 · E-Mail: sales@hhb.co.uk

HHB Communications Canada Ltd · 260 King Street East, Toronto, Ontario M5A 4L5, Canada
Tel: 416 867 9000 · Fax: 416 867 1080 · E-Mail: sales@hhbcanada.com

QUICK REFERENCE GUIDE

BurnIT COMPACT DISC RECORDER
CDRB30 COMPACT DISC RECORDER

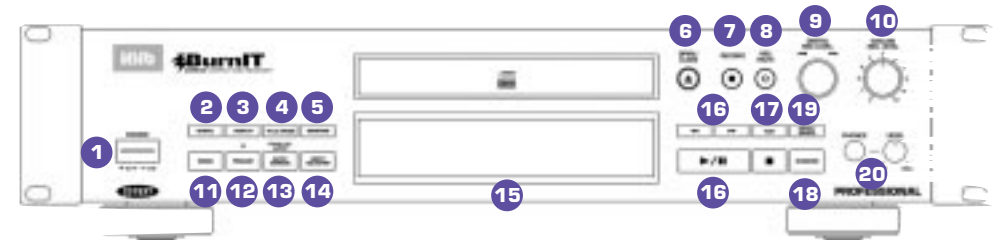

FEATURES & FUNCTIONS

- 1 POWER SWITCH**
Turns power to the unit on and off.
- 2 SCROLL**
Displays any CD Text information (if recorded), by scrolling the information across the display.
- 3 DISPLAY - BUTTON**
Selects the different time display modes - elapsed track time, remaining track time, total disc playing time, etc..
- 4 TITLE/MODE**
Selects the different name display modes; DISC NAME, ARTIST NAME and TRACK NAME if recorded.
- 5 MONITOR**
Enables the user to monitor the input signal prior to recording. This is possible even without a disc in the machine.
- 6 OPEN/CLOSE**
Press to open or close the disc loading tray.
- 7 RECORD**
For manually starting recording.
- 8 REC MUTE**
For creating 4 seconds or more of silence at the end of a recording.
- 9 ANALOG REC LEVEL**
Used for adjusting the level of the analogue input source.
- 10 DIGITAL REC LEVEL**
Used for adjusting the digital recording level, also accessing and setting the MENU functions and AMS track search.
- 11 ERASE**
Allowing user to erase CD-RW discs - last track, range of tracks, TOC (un-finalize) and INITIALISE (complete physical erase of whole CD-RW).
- 12 FINALIZE**
For making recordings Red Book compatible so that they can be played back in any CD player.
- 13 AUTO/MANUAL**
Switches between automatic and manual track numbering modes.
- 14 INPUT SELECTOR**
Selects the analogue, digital coaxial or digital optical input for recording purposes.
- 15 DISPLAY - SCREEN**
Shows recording and playback levels, disc and track time information, CD Text, selected input and other useful system information.
- 16 TRANSPORT CONTROLS**
Allowing playback, pause, FF, REW and STOP.
- 17 TEXT**
Allows the naming of the DISC, and the ARTIST, and also individual TRACK names, before finalization. This information is stored on the disc once finalized and can be read back by any CD Text compatible CD player.
- 18 SYNCHRO**
Allows automatic starting of recording from various sources, both digital and analogue. This is intended to simplify direct cloning of various source material [SYNC-1; SYNC-ALL; SYNC-FINAL].
- 19 MENU/DELETE**
Is used to access the various MENU page functions and delete characters in CD text mode. [MENU: COPY; FADER; T.INC; A.LVL; D.VOL; BALANCE].
- 20 PHONES - LEVEL**
Headphone socket (1/4") and headphone level control.

HOW TO RECORD USING DIGITAL INPUTS

1. Insert a recordable disc (CD-R or CD-RW)
2. Use the INPUT SELECTOR to select either the OPTICAL or COAX digital input depending on how you have connected the source machine to your CDR830.
3. If necessary adjust the DIGITAL RECORD LEVEL by accessing D.VOL in the MENU (Function 5). PLEASE NOTE THAT MOST COMMERCIAL RECORDINGS ARE OPTIMIZED FOR LEVEL AND SO IT IS NOT NECESSARY TO ADJUST DIGITAL RECORD LEVEL. Use this control when the signal level is too low or when you want to equalise the level of several tracks.
4. Start the recording manually by pressing RECORD. The CDR830 will first display the type of machine connected to the input (e.g. DAT, CD, MD,) and then display the sample rate of the source material (32, 44.1, 48K). The machine will then flash SET-UP in the display whilst it is performing its Optimum Power Calibration (OPC). Once set-up has stopped flashing, press the PLAY button to start recording. Press STOP to finish the recording.

OR

- Start the recording automatically using SYNCHRO.
- Ensure that the source material is not playing otherwise CHECK INPUT? will appear in the display.
- Press SYNCHRO to select SYNC-1 which automatically copies 1 track (useful for compilations).
- Press SYNCHRO again to select SYNC-ALL which is used to copy all tracks automatically.
- Press SYNCHRO again to select SYNC-FINAL which is the same as SYNC-ALL except that the disc will, in addition, be finalized automatically about 1 minute after recording has finished. Press STOP at any time to manually terminate the recording.

When recording finishes, the display will show PMA REC whilst the Programme Memory Area is written. DO NOT DISTURB OR SWITCH OFF THE MACHINE DURING THIS PROCESS.

HOW TO RECORD USING ANALOGUE INPUTS

1. Insert a recordable disc (CD-R or CD-RW)
2. Use the INPUT SELECTOR to select the analogue input.
3. Adjust the record level using the ANALOG REC LEVEL control preferably so that the signal peaks as close to '0' dBFS without going 'OVER'.
4. Start the recording manually by first pressing RECORD. The CDR830 will first display ANALOG and will then flash SET-UP in the display whilst it is performing OPC. Once set-up has stopped flashing, press the PLAY button to start recording. Press STOP to finish the recording.

OR

- Start the recording automatically using SYNCHRO.
- Ensure that the source material is not playing otherwise CHECK INPUT? will appear in the display.
- Press SYNCHRO to select SYNC-1 which automatically copies 1 track (useful for compilations).
- Press SYNCHRO again to select SYNC-ALL which is used to copy all tracks automatically.
- Press SYNCHRO again to select SYNC-FINAL which is the same as SYNC-ALL except that the disc will, in addition, be finalized automatically about 1 minute after recording has finished. Press STOP at any time to manually terminate the recording.

When recording finishes, the display will show PMA REC whilst the Programme Memory Area is written. DO NOT DISTURB OR SWITCH OFF THE MACHINE DURING THIS PROCESS.

AUTO-STOP FUNCTION

- In SYNCHRO recording mode, if the source is 16-bit, recording will automatically stop if the level falls below -96dBFS for 5 seconds or more.
- If the source is 24-bit, recording will automatically stop when the level falls below -90dBFS for 5 seconds or more. This is due to the built in dithering circuitry of the CDR830.

TRACK NUMBERING IN SYNCHRO & NORMAL MODES

- The CDR830 employs an intelligent track numbering scheme which adapts to the type of signal being recorded. It is also used to determine how the machine starts automatically in SYNCHRO mode.
- The following table shows how this scheme works.

MODE	INPUT	START METHOD	AUTO/MANUAL	TRACK INCREMENT METHOD
SYNCHRO	CD & MD [spdif]	Level > -90dBFS	AUTO	CD, MD Sub-code
SYNCHRO	DAT [spdif]	DAT START ID	AUTO	DAT START ID
SYNCHRO	ANALOGUE	Level > A.LVL in MENU	AUTO	LEVEL Threshold [A.LVL in MENU]
SYNCHRO	CD & MD [spdif]	Level > -90dBFS	MANUAL	None
SYNCHRO	DAT [spdif]	DAT START ID	MANUAL	None
SYNCHRO	ANALOGUE	Level > A.LVL in MENU	MANUAL	None
NORMAL	CD & MD [spdif]	Manual	AUTO	CD, MD Sub-code
NORMAL	DAT [spdif]	Manual	AUTO	DAT START ID
NORMAL	ANALOGUE	Manual	AUTO	LEVEL Threshold [A.LVL in MENU]
NORMAL	CD & MD [spdif]	Manual	MANUAL	None
NORMAL	DAT [spdif]	Manual	MANUAL	None
NORMAL	ANALOGUE	Manual	MANUAL	None

HOW TO PLAY BACK

1. Insert a recorded disc and press PLAY. The display will show the ▶ symbol.
2. Use the ◀ and ▶ to rewind and fast forward respectively.
3. Turn the DIGITAL RECORD LEVEL, ◀ ▶ during playback to skip backwards or forwards to a different track.
4. Use the supplied remote control to start playback from a particular INDEX number (see operations manual).

HOW TO ERASE (CD-RW ONLY)

1. There are 5 Erase modes for CD-RW; ERASE TOC (Un-finalizes a CD-RW)
ERASE LAST (Erases last track)
ERASE ALL (Erases all tracks)
ERASE RANGE (Erases a range of tracks)
INITIALIZE (see page 38 of the operations manual)
2. Press ERASE, then use 9 : to select the required erase mode.
3. Press PLAY.



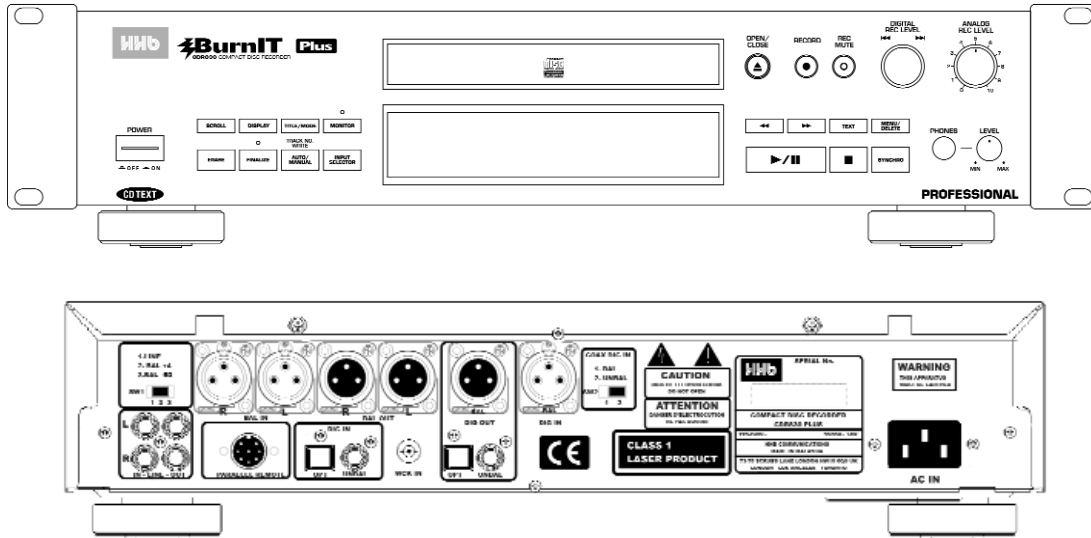

OPERATING INSTRUCTIONS SUPPLEMENT



Thank you for purchasing the HHB CDR830PLUS. This supplement is intended to provide the user with the additional information required to operate the CDR830PLUS and is to be used in conjunction with the standard Operating Instructions of the CDR830. We recommend that you read this manual first before you start using the CDR830PLUS. We also recommend that you keep this manual in a safe place for easy access in the future.

ADDITIONAL FEATURES

- Word clock input.
- Balanced digital input.
- Balanced digital output.
- Balanced analogue inputs with selectable line/microphone gain settings.
- Balanced analogue outputs.
- Parallel remote input.

WORD CLOCK INPUT

In today's digital studio environment, it is becoming more and more important to be able to lock/synchronise all digital equipment to a common sampling frequency or house clock. The effects of 'unlocked' equipment are all too noticeable as signal degradation, crackles and pops as machines 'clock' at different rates.

The CDR830 PLUS automatically detects whether there is a valid word clock signal connected to its word clock BNC input connector and if so, routes all digital outputs via a sample rate converter that is 'locked' to the same sampling frequency as the word clock input signal. If no valid word clock is detected at the input, then digital outputs will be clocked out at the 830's internal clock sampling frequency of 44.1kHz.

Note: When locked to an external word clock source, the digital outputs do not transmit p/q sub-code information.

BALANCED DIGITAL INPUT

The balanced digital input is compatible with both consumer and professional interface protocols. It has the electrical characteristics of a professional balanced interface (110 ohms input impedance).

In order to select the balanced digital input as source, perform the following:

1. Set the rear panel switch labelled SW2 to position 1. 'BAL'
2. Use the front panel INPUT SELECTOR to select COAXIAL.

BALANCED DIGITAL OUTPUT

The balanced digital output has the electrical characteristics of a professional balanced interface, the format characteristics of a consumer interface and is always active.

BALANCED ANALOGUE INPUTS

It is possible to record balanced line or microphone level analogue inputs.

In order to select a line level balanced analogue input as source, set the rear panel switch labelled SW1 to position 2. 'BAL +4'. Use the front panel INPUT SELECTOR to select ANALOG.

In order to select a mono or stereo microphone as source, set the rear panel switch labelled SW1 to position 3. 'BAL -60'. Use the front panel INPUT SELECTOR to select ANALOG.

BALANCED ANALOGUE OUTPUTS

The balanced analogue outputs have an output level of +18dBu for OdBFS.

PARALLEL REMOTE INPUT (DIN 8-pin)

By connecting the circuit shown below, remote control operation of this unit is possible with external switches. The parallel remote control has priority over the wireless remote control. When the same buttons are pressed at the same time on both units, operation with the parallel remote control will have priority.

REMOTE CONFIGURATION

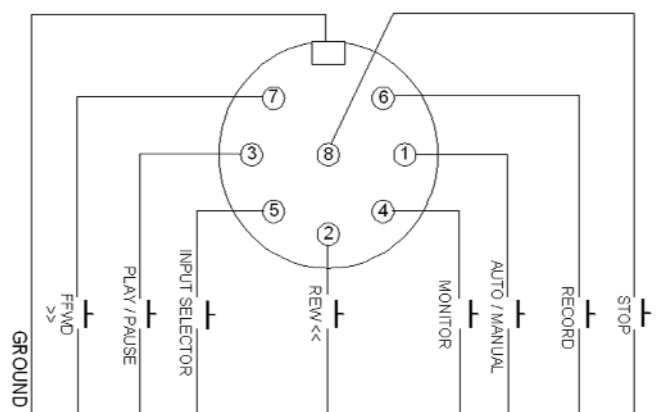

TECHNICAL DATA

HHB CDR830PLUS Compact Disc Recorder



Balanced Digital Output

Impedance 110 ohms
Amplitude. 4Vp-p 100 ohms load

Balanced Digital Input

Impedance. 110 ohms

Word Clock Input

Operating Frequency. 32kHz to 48kHz

Balanced Analogue Inputs (LINE; +4)

Level required for 0dBFS (gain @max). +5dBu +/- 1dB
Frequency response. 10hz to 20khz +/-1dB
THD+N. <0.01%

Balanced Analogue Inputs (MIC; -60)

Level required for 0dBFS (gain @max). -57dBu +/- 1dB
Frequency response. 20hz to 20khz +/-2dB
MIC EIN. -119dB 'A' Weighted +/-1dB
THD+N. <0.1%

Unbalanced Analogue Inputs (LINE; -8)

Level required for 0dBFS (gain @max). -8dBu +/- 1dB

Balanced Analogue Outputs

0dBFS gives +18dBu into a 10k load.

Unbalanced Analogue Outputs

0dBFS gives +8dBu into a 10k load.

NOTE: The specifications and design of this product are subject to change without notice, due to improvements.

Published by HHB Communications Ltd.
Copyright © 2002 HHB Communications Ltd.
All rights reserved.



FIRST WE LISTEN

Visit HHB online at www.hhb.co.uk

HHB Communications Ltd · 73-75 Scrubs Lane, London NW10 6QU, UK
Tel: 020 8962 5000 · Fax: 020 8962 5050 · E-Mail: sales@hhb.co.uk

HHB Communications USA Inc · 743 Cochran Street, Buildings E & F, Simi Valley, CA 93065-1976, USA
Tel: 805 579 6490 · Fax: 805 579 8028 · E-Mail: sales@hhbusa.com

HHB Communications Canada Ltd · 260 King Street East, Toronto, Ontario M5A 4L5, Canada
Tel: 416 867 9000 · Fax: 416 867 1080 · E-Mail: sales@hhbcanada.com